

**ChaoBao**<sup>®</sup>  
Commercial Products  
SINCE 1988

**ChaoBao**<sup>®</sup>  
Commercial Products  
SINCE 1988

2026

**ChaoBao**<sup>®</sup>  
Commercial Products  
SINCE 1988

要想生活好  
记得找超宝

TO BE A BETTER LIFE WITH CHAOBAO



超宝  
专业的  
清洁系统



**ISSA** MEMBER<sup>®</sup>  
THE EXPERTS  
ON CLEANING AND MAINTENANCE

美国国际清洁卫生协办会员

清洁设备国家标准起草单位  
CLEANING EQUIPMENT TO NATIONAL STANDARDS DRAFTING UNIT

中国超宝清洁设备集团  
CHINA CHAOBAO CLEANING PRODUCTS COMPANY

☎ 售后服务热线: 4008868648

公司总部  
GROUP HEADQUARTERS

地址: 广州市白云区江高镇神山工业园振华北路23号  
Add: 23#zhen hua North Road Shenshan Industrial Zone,  
Jiang Gao Town, Baiyun District, Guangzhou, China

国内销售部  
DOMESTIC SALES DEPARTMENT

电话TEL : (8620)8606 1188 / 8606 2288  
传真FAX : (8620)8606 3885 / 8606 3886

邮箱 E-mail: chaobao@china-chaobao.com  
阿里巴巴 Alibaba: www.china-chaobao.en.alibaba.com  
天猫店铺: 超宝旗舰店  
京东店铺: 超宝清洁用品官方旗舰店

沙溪门市部  
SHAXI MARKET DEPARTMENT

地址: 广州市番禺区南方沙溪酒店用品市场  
11街35-43档(华南快速干线沙溪出口)  
电话: (8620)8636 8798 / 8632 8069

出口部  
EXPORT DEPARTMENT

电话TEL : (8620)8606 3780  
传真FAX : (8620)8606 1250



微信公众平台

THE LATEST  
PRODUCT CATALOG

2026

PROFESSIONAL  
CLEANING SYSTEMS  
超宝 专业的清洁系统

中国超宝清洁设备集团  
www.china-chaobao.com

超宝全球服务热线  
**4008868648**

[www.china-chaobao.com](http://www.china-chaobao.com)



**Clean  
So simple**

**要想生活好 记得找超宝**  
TO BE A BETTER LIFE WITH CHAObAO



CHAObAO  
TO SOLVE THE GLOBAL  
CLEAN SYSTEM SCHEME

中国超宝  
清洁系统方案解决者

We are actively participating in the grand pattern of global competition and ready to make new strides.

We are engaged in a cause closely related to people's lives. Although it is ordinary, we are proud of it. At the same time, we are in the time full of strong competitors and challenges. No matter how huge success we achieve, we keep being grateful to customers and moving on with innovation and enthusiasm, to achieve sustainable development of enterprise.

Adhering to the enterprise spirit of "clean without boundaries, enjoy happiness together". Under the guiding strategy of promoting product innovation and optimizing the management structure as the core, we always stand at the forefront of cleaning industry, rewarding the market and customers with more efficient and scientific products. A ground-breaking and forward-looking blueprint is now in front of us.



CHAObAO  
CLEAN TECHNOLOGY  
LEADER

中国超宝  
清洁科技创新领导者

我们正积极参与到全球化竞争的宏大格局中，并时刻为成就新的跨越而做好准备。

我们所从事的是一项与人们生活息息相关的事业，虽然平凡，却让我们引以为傲；与此同时，我们有正身处于强者如林且充满挑战的时代，在取得成绩的同时我们应该更应保持警醒——以一颗感恩客户之心和依靠不断创新为动力，不断前行，实现企业的持续发展。

秉承着“清洁无界，幸福同享”的企业精神，在推动产品创新和优化管理结构为核心的战略指引下，我们始终屹立于行业前沿，以更加高效、科学的产品回报市场和客户……一个深具开拓性和前瞻性的蓝图正呈现在我们面前。

董事长：  
President Mr.

# 浩海国际科技产业园

INTERNATIONAL SCIENCE AND TECHNOLOGY INDUSTRIAL PARK



## 与时俱进 永恒动力

Keep pace with the times, eternal power

The concept of Chaobao company's technological industry zone is "Advanced technology, innovation Research, Cultural ecology" for the development of elements. Environmental protection equipment is Chaobao's main industry. The technological industry zone gathers research and development sector, demonstration sector and marketing sector, etc.

Chaobao Company held the 5G+ industrial internet intelligent lean transformation forum in the sharing center. Here we discuss how environmental protection machinery and equipment can improve the industrial internet level. In this way, intelligent transformation and benefit enhancement can be realized.

A high-tech enterprise in the High-tech zone with special environmental equipment and intelligent environmental protection machinery and equipment as its main products. This enterprise is located in the north of Chuangxin Street and east of Luohu Avenue in Luohu District, Zhaoqing city High-tech Zone, the land area is about 200100 square meters (300 mu). The main products are R&D and manufacturing: automatic sweeping robots, automatic washing machines, intelligent washing equipment, cleaning and environmental protection equipment, unmanned washing machines, cleaning robots, automatic sweeping machines, battery type automatic washing and drying machines, and multi-functional brushing machines, sofa machines, vacuum cleaners, hair dryers and other cleaning equipment. It has the advantages and characteristics of high-tech and environmental protection, high technical content, large added value of products, and extensive to the international market.

To become a caring company that cares about employees, customers and society, Chaobao Group will adopt modern management combining 8S and "three modernizations", to create a better, safer, happier workplace for employees. The open office area and orderly production workshop will definitely leave a deep memory for you. Let customers appreciate Chaobao's environmental protection and intelligent manufacturing, meticulous research and development, and the concept of achieving the future. Chaobao, as China's leading international brand of cleaning products in the world, contributes to human health, hygiene and clean environment.

超宝集团科技工业园理念为“前沿科技、创新研发、文化生态”为发展要素，以环保设备为主导产业，集科技研发、展示、商务推广于一体的综合科技产业园区。

超宝集团在共享中心举办5G+工业互联网智能精益转型论坛，共同探讨环保机械设备如何提升工业互联网水平，实现智能转型与效益提升。

高新区内一家以环境专用设备、智能环保机械设备为主打产品的高新技术企业。位于肇庆市高新区罗湖片区创新大街北面、罗湖大道东面，用地面积约200100平方米(300亩)。主营产品为研发制造：自动扫地机器人、自动清洗机、智能洗地机设备、清洁环保设备、无人驾驶式洗地机、清洁机器人、自动扫地机、电瓶式自动洗地吸干机、多功能刷机沙发机，吸尘吸水机，吹风机等清洁设备机械，其具有高新环保、技术含量高、产品附加值大、国际市场广泛等优势 and 特点。

成为一家关怀企业，关怀员工，客户和社会的企业，超宝集团将透过8S与“三化”相结合的现代化管理，即：厂区公园化、车间花园化、办公室家庭化。开放式的办公区域和井然有序的生产车间，一定会给您留下深刻的记忆。让客户领略超宝[绿色智造，精益研发，成就未来]的理念。超宝作为中国在全球清洁用品的国际领导品牌，为人类健康、卫生清洁环境作出贡献。

# 超宝清洁集团总部

CHAobao CLEANING GROUP HEADQUARTERS



## 追求卓越 勇创一流

Pursure excellence create first-class

Guangzhou Chaobao Cleaning Products Company was founded in 1988. It's located in Shenshan Industrial Zone, Jianggao Town, Guangzhou. And it is one of the most well-known cleaning machinery and equipment manufacturing enterprises in the world. Chaobao is a modern factory occupied 200,000 square meters, it has variety cleaning products to meet customer's demand. Such as, ride-on scrubber dryer, sweeper machine, battery automatic scrubber dryer, multifunctional brushing machine, weighing renewing machine, vacuum cleaner, sofa maintainer, blower and other cleaning equipment. And it also supply cleaning tools, dustbin, chemical some hotel supplies. Chaobao established a professional Research and Development Department to develop more popular products for consumers. All of those products are most representative in domestic market, and they're hot selling over 120 countries and regions under close relationship with more than 3000 dealers around the world. Chaobao already became one of the most well-known representative in domestic cleaning products industry. Its products are widely used at the Asian Games, railway, airports, enterprises, hotels, office buildings etc. Chaobao company has successfully passed ISO9001:2000 international Quality Management system Certificate, CE, ROHS, GS, UL and rewarded nearly 60 national patents. As its great influence in Guangdong, Chaobao awarded "high-tech enterprise", "harmonious enterprise", and "top 50 private enterprise" in 2017. And it is approved as Integrity Enterprise, A-class taxpayer for decades. Taking the responsibility of vice president of Guangdong Province Hotel Industry Association, Chaobao keeps close technical cooperation with all leader enterprises to gain advanced production and management experience. China Chaobao Cleaning Equipment Group set up Guangdong Haoyu Cleaning Environmental Protection Equipment Co., Ltd in September, 2012, and found Guangdong Goodpingao Cleaning Technology and Equipment Co., Ltd in 2014. Goodpingao brand is specialized in developing high-grade cleaning machinery and cleaning supplies. We will advance with the times to provide better products in the future. Our mission and vision is to be the leader in the line of cleaning industry, and be the best choice for user's.

中国超宝清洁用品公司创办于1988年，位于广州市江高镇神山工业园，是全球清洁设备制造行业的知名企业，是亚洲专业的清洁用品出口供应商。超宝公司现拥有现代化园林式厂房20多万平方米。主要经营范畴：自主研发制造驾驶式洗地吸干机、扫地机、电瓶式自动洗地吸干机、多功能刷机、加重翻新机、吸尘吸水机、沙发机和吹风机等清洁机械设备，及清洁工具、垃圾桶、清洁剂和酒店、客房用品等。集团设有专门的产品研发中心，所生产的清洁机械在国内极具代表性，产品畅销世界120多个国家与地区，得到全球近3000家专业经销商的青睐合作。“CHAobao”品牌已成为国内清洁用品行业最具知名度的品牌代表。产品已为如：亚运会、高铁项目、机场与众多大型企业、星级酒店、写字楼、清洁服务行业等场所使用。

中国超宝公司已先后取得ISO9001:2000国际质量管理体系认证，欧洲CE、ROHS、GS、美国UL等认证，拥有近60项国家专利，是广州市与广东省著名商标企业。2017年为广东省科学技术厅授予“高新技术企业”，被评为“和谐企业”，“民营企业50强”。

超宝连续14年被评为广东省守合同重信用单位，连续15年被评为广州市A级纳税人与纳税大户，是广东省酒店行业协会副会长单位。多年来，我们坚持与全国各大行业龙头企业通力合作，建立了紧密的技术合作与良好关系，使我们获得了先进的生产管理经验，为我们的稳步发展提供了源源不断的技术支持与品质保障。

超宝公司于2012年9月成立广东浩宇清洁环保设备有限公司，2014年成立广东美品高清洁科技设备有限公司，专注于开发生产高档清洁机械及高级清洁用品。在今后的发展中，我们将与时俱进，做得更好！

# 超宝全球服务网络

CHAObAO GLOBAL SERVICE NETWORK

# ChaoBao®

Commercial Products  
SINCE 1988

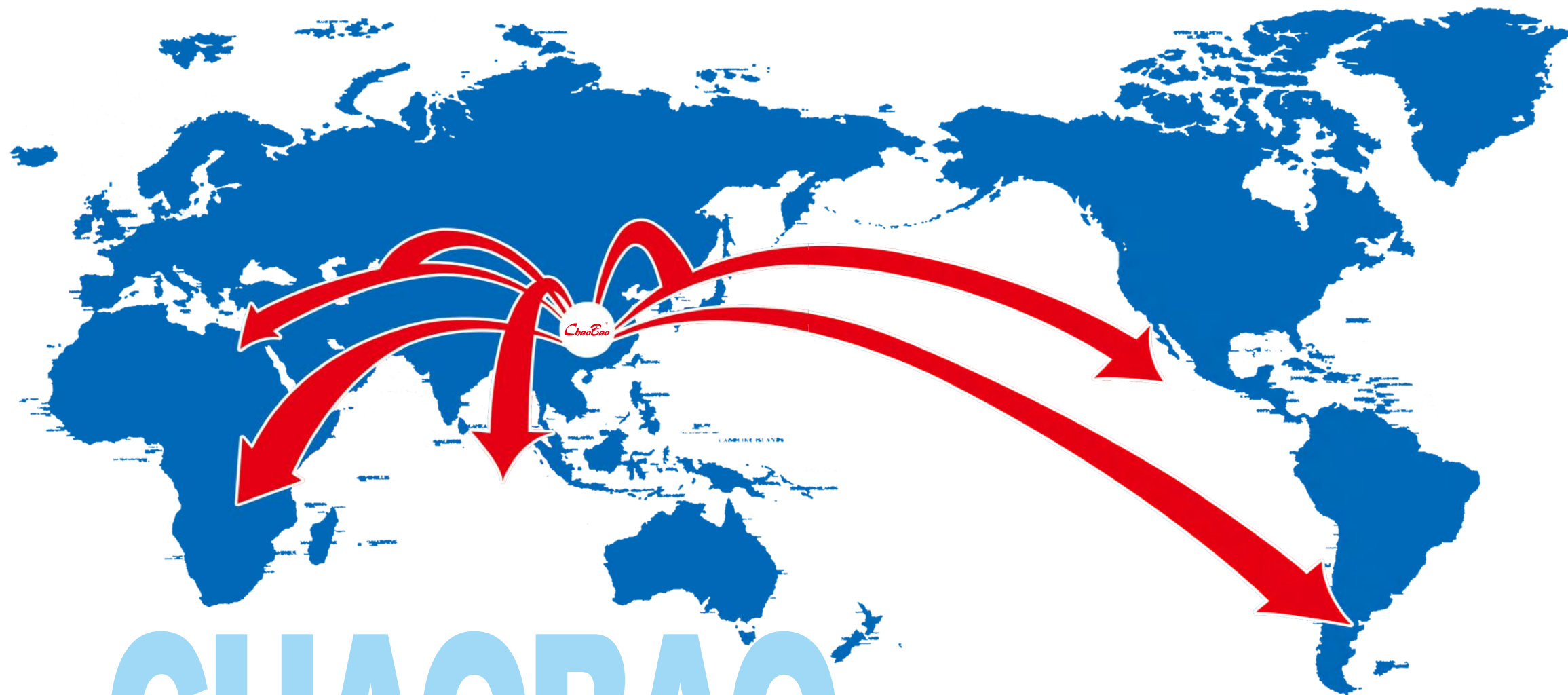

# CHAObAO

<b>UK, Russia, Italy</b> (英国、俄罗斯、意大利) : TEL: 19022026850 E-mail: happy@china-chaobao.com	<b>Saudi Arabia, Kuwait, Australia</b> (沙特阿拉伯、科威特、澳大利亚) : TEL: 19065252286 E-mail: star@china-chaobao.com
<b>India, Middle East (印度、中东) :</b> TEL: 19022002306 E-mail: great@china-chaobao.com	<b>Turkey, Egypt (土耳其、埃及) :</b> TEL: 15902060228 E-mail: jenny@china-chaobao.com
<b>Europe (欧洲) :</b> TEL: 19022016690 E-mail: power@china-chaobao.com	<b>Hong Kong, Macao, trading company</b> (香港、澳门、贸易公司) : TEL: 15622234432

**North America, Africa (北美洲、非洲) :**  
TEL: 19076004684  
E-mail: trust@china-chaobao.com

**South America, Central America (南美洲、中美洲) :**  
TEL: 19022033212,  
E-mail: sky@china-chaobao.com

**Malaysia, Singapore, Thailand, Japan, South Korea, Central Asia (马来西亚、新加坡、泰国、日本、韩国、中亚地区) :**  
TEL: 19022033036  
E-mail: blue@china-chaobao.com

**Southeast Asia (东南亚) :**  
TEL: 19022012253  
E-mail: pretty@china-chaobao.com

**华北地区营销部**  
North China Marketing Department  
北京: 020-86063310  
河北、内蒙古、山西: 020-26261512  
天津: 020-26261476

**东北地区营销部**  
Northeast China Marketing Department  
黑龙江、吉林、辽宁: 020-26261476

**华东地区营销部**  
East China Marketing Department  
江苏: 020-86447070  
福建、江西、安徽: 020-86063766  
浙江: 020-86062893  
山东: 020-86602275、020-86448213

**华中地区营销部**  
Central China Marketing Department  
湖南、湖北: 020-86062620

**华南地区营销部**  
South China Marketing Department  
海南: 020-86062893  
广西: 020-86062620

**西南地区营销部**  
Guangdong area Marketing Department  
重庆: 020-26261506、020-26261460  
四川: 020-86062391、020-86448043  
云南、贵州: 020-86063851、020-86447117

**西北地区营销部**  
Northwest China Marketing Department  
宁夏: 020-86448271  
西安、兰州: 020-36098389

# 质量保证体系

## QUALITY SYSTEM

# CHAObAO

### A 质量同行 诚信同心

#### Quality Assured Integrity To Others

超宝已经获得ISO9001:2000国际质量管理体系认证，欧洲CE、ROHS、GS、美国UL等认证，拥有近60项国家专利，最大可能的保证了超宝产品的可靠品质及市场竞争优势。

China Chaobao Cleaning Company has received ISO 9001:2000 international quality management system certification, Euro CE, ROHS, GS, UL certification, with nearly 60 national patents, for the assurance of our products' reliable quality and market competitive advantage.



### D 全面的质量管理体系

#### Comprehensive Quality Management System

超宝公司先后取得ISO9001:2000国际质量管理体系认证、欧洲CE、ROHS、GS、美国UL等认证，完善的质量控制与质量保证系统保证了每个供应商都经得起严格考验，每个零配件都经过了精挑细选，每一道工序都经历了千锤百炼，每一个产品都力求做到“零缺陷”!

China Chaobao Cleanings achieved ISO 9001:2000 Company has International Quality Management System Certification Certificate, CE, ROHS, GS, UL certification, the perfect quality Control and quality assurance system to ensure that each supplier can withstand rigorous quality test. Thoroughly tempered, each process and each product will strive to achieve "zero defect"!

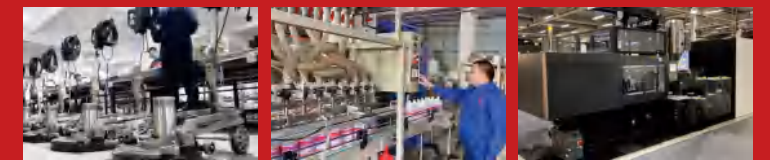

### B 完善的产品开发体系

#### Complete Product Development System

超宝公司拥有一批高素质、经验丰富的开发团队致力于技术创新，建立了行业独一无二的技术研发体系。目前，超宝累计拥有国内外60余项专利，而且不断推出广受市场欢迎的新产品。

China Chaobao Cleaning Company has a number of highly qualified and experienced development team, who are committed to technological innovation, established a unique technology industry R&D system. Currently, Chaobao Cleaning has accumulated into more than 60 domestic and foreign patents, and has introduced many new products which are welcomed by the market.



### E 全球产品销售与服务网络

#### Global Sales And Service Network

超宝在拓展全球市场的战略上，为全球经销商及时提供产品和售后服务，真诚服务于美洲、欧洲、非洲、东南亚，以及中国本地近四千家分销商。超宝将以坚持不断创新的精神和真诚的服务理念，不断提供设计新颖和性能优异的产品建立起一个专业的全球清洁行业用品生产基地。

On the expanding the global market strategy, China Chaobao Cleaning Company afford product and service for global distributors timely, sincere service to the customers in America, Europe, Africa, Southeast Asia and 4000 local distributors. We will adhere to continuous innovation and sincere service concept, continue to provide innovative design and excellent performance products, to establish a global professional cleaning industry supplies production base.

### C 业内领先的产品生产设备与工艺

#### Industry-leading Production Equipment And Technology

超宝公司既注重技术，同时通过先进的设备和工装，以及不断提高的工艺水平始终保持着制造方面的优势；超宝集团目前拥有行内最为齐全最为先进的注塑滚塑及电机、铸造等生产线，形成了一套高质量、高效率的清洁产品生产流程。

China Chaobao Cleaning Company not only focus on technology, also pay attention to advanced equipment and tooling, to keep the manufacturing advantages. Now China Chaobao Cleaning Equipment Group has the most complete and advanced injection molding, rotational molding and electrical machine, casting and other production lines, forming a high-quality, high-efficiency cleaning products production processes.



# Discovery



## ChaoBao

### Quality Journey

# 文化传承 人才兴企

## CULTURA LINHERIT TALENTS AGGREGATION

企业文化是一个企业的灵魂，是推动企业发展的不竭动力，超宝公司经过三十多年的发展，形成了具有自己特色的“以人为本、以客为尊、以信为德、可持续发展”的企业文化，这是一种精神财富，它指引着超宝人不断超越创造辉煌。

Culture is the soul of an enterprise, is the driving force to promote, CHAOBAO company after more than 30 years of development, formed with "people-oriented, customer-oriented credit is morality, sustainable development" of the culture, this is a kind of spiritual wealth, it guided CHAOBAO constantly gobeyond, to create brilliant.



# 文化理念

## CULTURAL CONCEPT

### A

#### 以人为本 People oriented

超宝是每个积极上进的员工放飞梦想的舞台!  
超宝不会忘记每一个携手共进的员工!  
超宝给予每一个员工公平公正的机会!  
超宝会全力挖掘与发挥每个员工的潜能!

Chaobao motivated employees to fly their dream!  
Chaobao will not forget every staff hand in hand!  
Chaobao give the opportunity to every employee fairly!  
Chaobao will fully tap the potential of each employee!

### C

#### 以信为德 Credit Is Morality

超宝以诚信作为商业信条!  
超宝以诚信作为社会形象!  
超宝以诚信作为职业操守!

Chaobao use good faith as a business creed!  
Chaobao use in good faith as a social image!  
Chaobao use good faith as career ethics!

### B

#### 以客为尊 Customer-Oriented

超宝依存于我们的客户!  
顾客满意是我们超宝生存发展的根本!  
想客户所想，急客户所急，永远超值交付!

Dependent on our customers!  
Customer satisfaction is fundamental to our survival!  
We are always seek to satisfy what are the customers think and what are the customers need!

### D

#### 可持续发展 Sustainable Development

培养最具创造力的团队，  
创建以责任为文化的企业，  
不断创新，持续改进，追求永续经营!

Cultivate the most creative team and a company with responsibility for culture. Continuous innovation, continuous improvement make the continuous business.



# 人才理念

## TALENT CONCEPT

人人都是人才  
珍视每一位员工的存在  
关心每一位员工的未来

Everyone is a Talent  
Cherish Every Employee  
Concern About The Future Of Every Employee

- 选才: 品德第一，注重实践，不拘一格  
CHOOSE: Morality and practice are very important
- 育才: 创造有利于学习成长的环境，提供多样的工作机会，铺设因人而异的成才之路  
DEVELOP: To create an environment conducive to learning and growth
- 用才: 扬长避短，使人尽其才，才得其用，用显其效  
USE: Avoid weaknesses, make full use of talents

# 6S 管理体系

## 6S MANAGEMENT SYSTEM



#### 整理(SEIRI)

意义: 将工作场所的任何物品区分为有必要和没有必要的，除了有必要的留下来，其他的都消除掉  
目的: 腾出空间，空间活用，防止误用塑造清爽的工作场所

#### 整顿(SEITON)

意义: 把留下来的必要用的物品依规定位置摆放，并放置整齐加以标识  
目的: 工作场所一目了然，消除寻找物品的时间，整整齐齐的工作环境消除过多的积压物品

#### 清扫(SEISO)

意义: 将工作场所内看得见与看不见的地方清扫干净，保持工作场所干净、亮丽的工作环境  
目的: 稳定品质，减少工业伤害

#### 清洁(SEIKETSU)

意义: 将整理、整顿、清扫进行到底，并且制度化，经常保持环境外在美观的状态  
目的: 创造明朗现场，维持上面3S成果

#### 素养(SHITSUKE)

意义: 每位成员养成良好的习惯，并遵守规则做事，培养积极主动的精神(也称习惯性)  
目的: 培养有好习惯、遵守规则的员工，营造团队精神

#### 安全(SEcurity)

意义: 重视成员安全教育，每时每刻都有安全第一观念，防范于未然  
目的: 建立起安全生产的环境，所有的工作应建立在安全的前提下

# 产品展览与晚宴

## PRODUCT EXHIBITION AND DINNER

### 品质呈现 扬名中外

### Excellent Quality Famous in the world



公司大楼三千平方米  
产品展厅  
Three thousand square  
meters show room in the  
company building

▲ 超宝广州沙溪展厅  
▼ Shaxi show room in Guangzhou

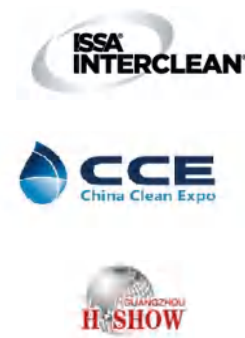

公司总部拥有八千平方米的产品展厅，并且分别在南方沙溪酒店用品市场和广东南国小商城设立门店展厅，产品种类齐全，方便客户详细了解产品；随着超宝国际化脚步不断加快，超宝产品的身影频繁出现在海外市场当中，以其优异的产品性能，获得国内外广大客户认可。

The company's headquarters boasts an 8,000-square-meter product exhibition hall, and has also set up storefront exhibition halls respectively in the Southern Shaxi Hotel Supplies Market and Guangdong Nanguo Small Mall. With a complete range of products, it is convenient for customers to gain a detailed understanding of the products. As Chaobao accelerates its internationalization pace, Chaobao products have frequently appeared in overseas markets. Relying on their excellent product performance, they have won recognition from a large number of customers at home and abroad.



# 超宝在中国

CHAObAO in China



# 超宝在国际

CHAObAO internationally



# 我们的团队

## OUR TEAM

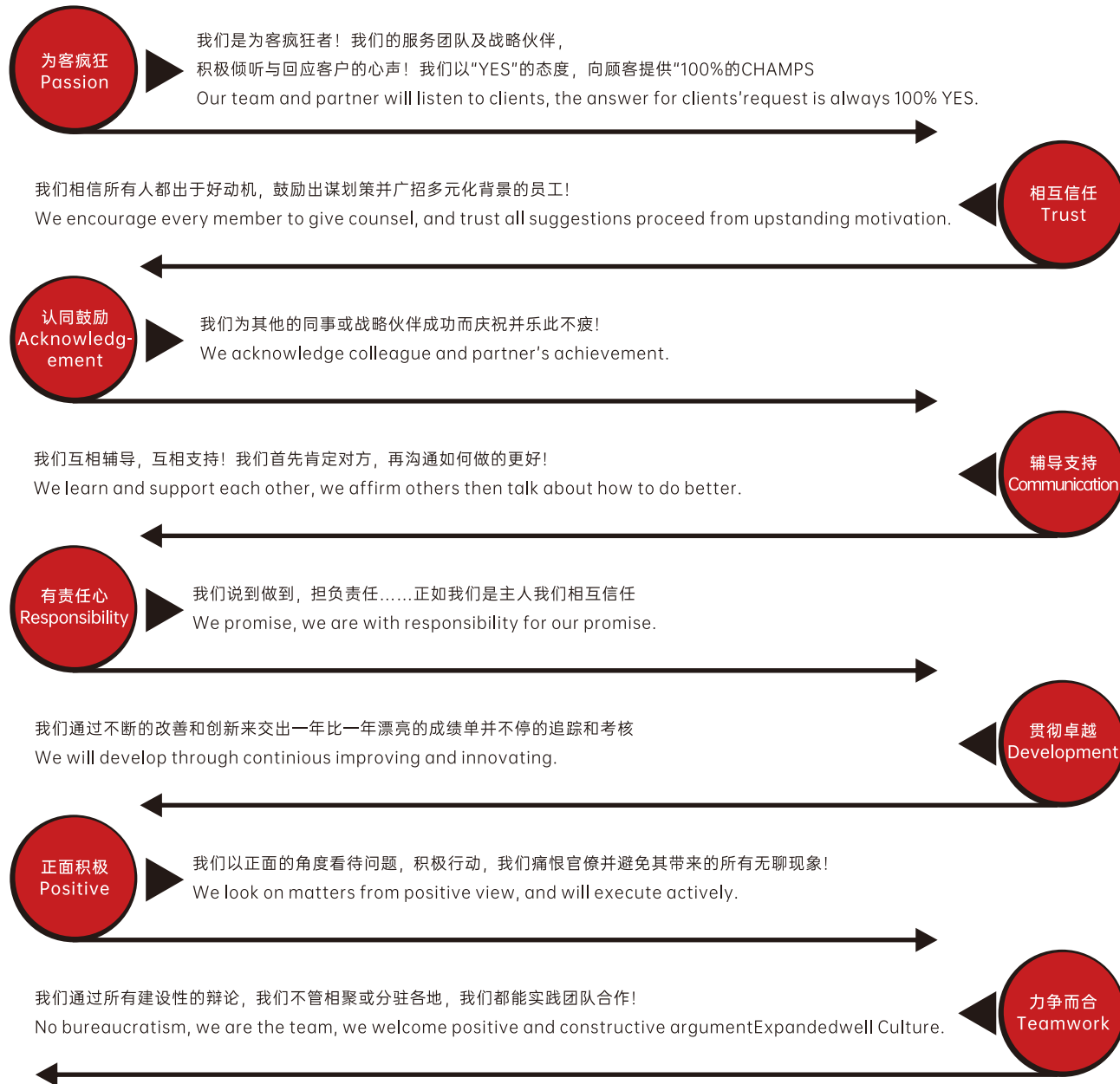

**我们不只重视伙伴们工作专业能力的培养  
 更强调并落实伙伴们的工作服务态度**

*we not only pay attention to professional ability training  
 we focus on service attitude more*

# 我们的服务

## OUR SERVICE



# 辉煌历程 荣誉见证

## GLORIOUS COURSE HONORS WITNESS

公司历经三十多年的稳健发展，依靠科技创新和科学管理，获得了社会各界的认可和众多荣誉，一路走来，那一块块奖牌就是我们成长的足迹。

After more than 30 years development, relying on scientific and technological innovation and scientific management, the company has won recognition and many honors. Along the way, the medals are the footprints of our growth...



十大著名品牌企业



百强企业



示范性企业工会



重合同守信用企业



和谐劳动关系企业



科技小巨人企业



高新技术企业

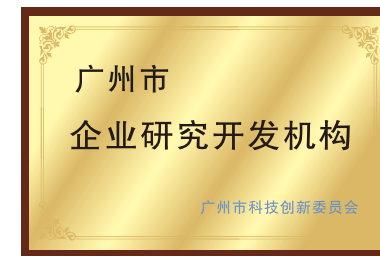

企业研究开发机构

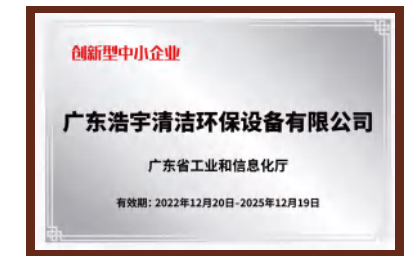

创新型中小企业



CE认证



ISO9001:2000认证



3C认证



3C认证



3C认证



检验报告认证



广东省重点商标



市级企业技术中心



专精特新中小企业

# 目录

## CATALOG

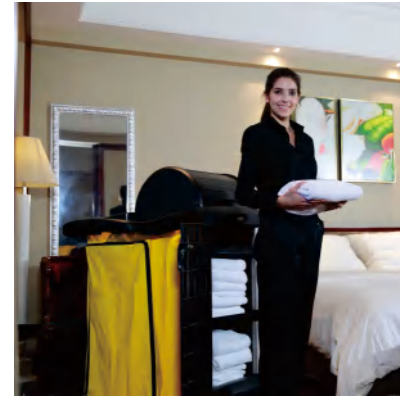

### 公司

#### COMPANY

	PAGE
董事长致辞 SPEECH BY THE CHAIRMAN OF THE BOARD	A02
公司介绍 ABOUT US	A03
质量保证体系 QUALITY ASSURANCE SYSTEM	A09
企业文化与人才理念 CORPORATE CULTURE	A11
产品展厅 PRODUCTS SHOW ROOM	A13
企业荣誉 CORPORATE HONOR	A19

### 设备

#### CLEANING EQUIPMENTS

	PAGE
洗地机系列 SCRUBBER DRYER SERIES	001
扫地机系列 SCRUBBER MACHINE SERIES	023
沙发机 SOFA MAINTAINER	029
地毯抽洗机 CARPET MACHINEE	031
吸尘器 VACUUM CLEANER	035
吸尘吸水机系列 VACUUM CLEANER AND WATER SUCTION MACHINE SERIES	
超劲霸吸尘吸水机 SUPER STRENGTHWET AND DRY VACUUM CLEANER	039
超劲宝吸尘吸水机 SUPER POWER WET AND DRY VACUUM CLEANER	041
超宝牌吸尘吸水机 CHAUBAO WET AND DRY VACUUM CLEANER	043
超贝牌吸尘吸水机 CHAIBEI WET AND DRY VACUUM CLEANER	051
超静音吸尘机 SUPER SILENT VACUUM CLEANER	057
星空洁牌吸尘吸水机 AIR CLEAN WET AND DRY VACUUM CLEANER	059
刷地机 SCRUBBING MACHINE	063
风机 BLOWER	085
配件 ACCESSORIES	089

### 塑料制品

#### PLASTIC

	PAGE
圆形储物桶 CIRCULAR BIN	099
环保垃圾桶系列 ENVIRONMENT PROTECTION DUSTBIN	107
新款垃圾桶 NEW TRASH CAN	113
小型垃圾桶 SMALL TRASH CAN	123
工具篮 TOOL BUCKET	125
榨水车 WRINGER TROLLEY	131
告示牌 CAUTION BOARD	139

超宝八大专业市场清洁系统  
EIGHT PROFESSIONAL  
MARKETCLEANING SYSTEM

### 工具/服务车

#### TOOL/TORLLEY

	PAGE
清洁车 CLEANING	147
客房用品 GUEST ROOM SUPPLIES	163
尘推与拖把 MOP	169
清洁工具及配件 CLEANING TOOLS AND ACCESSORIES	180
垃圾袋 GARBAGE BAG	199

### 酒店用品

#### HOTEL SUPPLIES

	PAGE
纸巾 PAPER TOWEL	201
大堂用品 LOBBY SUPPLIES	209

### 清洁剂

#### CLEANING AGENT

	PAGE
清洁剂系列 CLEANING AGENT SERIES	219
家庭装系列清洁剂 HOME SERIES CLEANING PRODUCTS	221
经济商用清洁剂 ECONOMIC COMMERCIAL CLEANER	227
经典加仑装清洁剂 CLASSIC GALLON OF CLEANING AGENT	233
清洗程序指导 CLEANING PROCEDURE GUIDANCE	268



酒店清洁  
Hotel Cleaning



物业管理清洁  
Estate Management  
Cleaning



餐饮清洁  
Catering Cleaning



娱乐/交通清洁  
Entertainment/Traffic  
Cleaning



公共机构清洁  
Public Institution  
Cleaning



连锁卖场清洁  
Chain Stores Cleaning



连锁卖场清洁  
Manufacturing Industry  
Cleaning



医疗保健清洁  
Health Care Cleaning



# 商用清洁机器人 COMMERCIAL CLEANING ROBOT

## HH ROBOT 01

### 商用清洁机器人 COMMERCIAL CLEANING ROBOT



行走导航 Walking navigation		清洁效率 Cleaning efficiency		人机交互 Human-computer interaction	
行走速度 Walking speed	自动: 0.4/0.5/0.6m/s 手动: 1m/s max	最大清洁效率 Maximum cleaning efficiency	1440m <sup>2</sup> /h (typ1000m <sup>2</sup> /h)	巡逻 Patrol	高清摄像头 High-definition camera
驱动方式 Drive mode	双轮差速	滚刷转速 Roller brush speed	500rpm	语音交互 Voice interaction	麦克风阵列 Microphone array
爬坡度 Climbing gradient	约6°, 自动4°	刷盘转速 Spiral speed	200rpm	梯控 Ladder control	选配 Optional
导航精度 Navigation accuracy	+5cm	边刷直径 Brush diameter	230mm	机身人机交互屏 Fuselage man-machine interaction screen	支持 Support
空间建图 Map building in space	支持	尘推布尺寸 Dust mop size	420x160mm	管理员与操作用户分开管理 Administrators and operational users are managed separately	支持 Support
建图方式 Graph construction method	支持远场3D激光 实时空间点云建图	扫地 Sweep the floor	支持	设置修改密码 Set to modify password	支持 Support
建图速度 Graph construction speed	相对空旷的地方: 110000m <sup>2</sup> x5-10分钟	吸尘 Suck the dust	支持	可设置多个自动化任务 Multiple automation tasks can be set up	支持 Support
点到点导航 Point-to-point navigation	支持	尘推 Dustpan	支持	可手动与自动控制切换 Switch between manual and automatic control	支持 Support
自动规划路径 Automatic path planning	支持	便捷功能 Convenient function		可导航不同地图 Navigate different maps	支持 Support
机械障 Mechanical failure	支持	云端管理 Cloud management	支持	可不同位置校准机器 Machine for calibration at different positions	支持 Support
超声避障 Ultrasonic obstacle avoidance	支持	超支持手/自一体清洁 Support hand/automatic integrated cleaning	支持	可设置手动模式行进速度 Can set the manual mode travel speed	支持 Support
多传感器绕障 Multi-sensor obstacle avoidance	支持	尘盒快拆 Dust box quick disassembly	支持	机械行走虚拟操作杆 Mechanical walking virtual joystick	支持 Support
回扫能力(避障后回扫) Return scanning capability (after obstacle avoidance)	支持	尘推部件快拆 Dustpan parts quick release	支持	可单独控制清洁功能 Independent control of cleaning function	支持 Support
设置虚拟墙 Set virtual wall	支持	旋风筒快拆 Quick-release cyclone drum	支持	显示当前执行任务 Display the current executing tasks	支持 Support
地图优化 Map optimization	支持	静电绒条快拆 Static electricity velvet strip quick release	支持	顶栏对应功能图标动态显示 Top bar corresponding function icon dynamic display	支持 Support
实时显示机器位置 Real-time display of machine position	支持	紧急制动 Emergency braking	支持	紧急或错误智能报警 Emergency or error intelligent alarm	支持 Support
				系统信息显示 System information display	支持 Support
				中英文切换 Chinese and English switching	支持 Support



HH ROBOT 03 商用清洁机器人  
COMMERCIAL CLEANING ROBOT



万平米级  
室外清扫专家



产品优势

高智能

高精建图、智能轨迹规划  
动态记忆清扫  
复杂场景自主绕障、避障  
低电量自主回充、泊车识别报警  
云端车队管理，多车实时监控

更节约

一机解决4人以上清洁任务量  
降低综合成本

高效率

小时超长续航  
24小时跨昼夜循环作业  
沿边清扫无死角，垃圾不留痕  
100L超大容量垃圾箱

更安全

激光雷达、超声波多传感器融合  
360度无盲区感知识别

高颜值

科技化外观设计  
多种皮肤颜色供选择

更精准

无GNSS和弱GNSS区域  
毫米级精度定位

结构参数 Structural parameters		电气参数 Electrical parameters		清扫参数 Cleanup parameters	
外形尺寸 Dimensions	163x120x122cm	电池类型 Battery Type	磷酸铁锂电池	清扫宽度 Sweeping width	1200mm
清扫车总重量 Sweeper total weight	320kg	平均续航时间 Average battery life	4-6小时	清洁效率 Cleaning efficiency	最大4000m/h
电池重量 Battery weight	38kg	最大功率 Maximum power	2000W	安全系统 Safety system	激光雷达、视觉系统 超声波传感器
垃圾箱容积 Trash can capacity	100L	额定电压 Rated voltage	48V	行进速度 Marching speed	0-8km/h
工作温度 Working temperature	-15°C~+60°C	额定驱动电机功率 Rated power of driving motor	800W	备注*	清扫车重量指的是清扫车空载状态下的重量 该重量包含电池重量
运行噪音 Operating noise	55~70dB(a)	额定刷盘电机功率 Rated power of brushless motor	2x90W		
运行坡度 Grade	≤12度	额定主刷功率 Rated main brush power	800W		



# 清洁设备 CLEANING EQUIPMENT

## CB660 驾驶式洗地吸干机 RIDE-ON SCRUBBER DRYER

产品尺寸 product size	1470x740x1190mm	刷盘压力 brush pressure	30kg
净重 net weight	230kg	刷盘直径 diameter of brush disc	13寸
毛重 Gross weight	245kg	刷地宽度 working width	660mm
清水箱容量 cleaning water tank volume	65L	吸扒宽度 squeegee width	1050mm
污水箱容量 sewage tank volume	70L	驱动电机功率 rear drive motor power	500W
工作效率 working efficiency	3000m <sup>2</sup> /h	刷盘电机功率 washing brush power	380Wx2
连续工作时间 working time	2-3hours	吸水电机功率 suction motor power	500W
电瓶充电时间 Battery charging time	8hours	电压 voltage	DC 24V
电池 battery	120Ah		



## CB860 驾驶式洗地吸干机 RIDE-ON SCRUBBER DRYER

产品尺寸 product size	1710x840x1360mm	刷盘压力 brush pressure	30kg
净重 net weight	375kg	刷盘直径 diameter of brush disc	18寸/440mm
毛重 Gross weight	400kg	刷地宽度 working width	860mm
清水箱容量 cleaning water tank volume	95L	吸扒宽度 squeegee width	1150mm
污水箱容量 sewage tank volume	130L	驱动电机功率 rear drive motor power	600W
工作效率 working efficiency	4500m <sup>2</sup> /h	刷盘电机功率 washing brush power	550Wx2
连续工作时间 working time	3-4hours	吸水电机功率 suction motor power	500W
电瓶充电时间 Battery charging time	8hours	电压 voltage	DC 24V
电池 battery	6V/200Ah*4		



## 超宝驾驶式洗地机 RIDE-ON SCRUBBER DRYER



工作宽度: **860mm** Working Width  
最大工作效率: **4500m<sup>2</sup>/h** Maximum Working Efficiency

超宝驾驶式洗地机系列提供极高的稳定性及耐用性, 人性化操作界面设计, 适合各种类型的地面清洗任务。

ChaoBao driving type sweeping machine provide high stability and durability, it is with humanized operation interface design, it is suitable for various kinds of ground sweeping.

- 人性化设计, 驾驶轻松, 操控灵活, 清洗效率高
- 强劲吸水电机同步抽走污水, 超静音设计, 减少对操作人员和周边环境的噪音影响
- 机器设置自动和手动两种操作模式, 工作效率高, 清洁彻底

- Humanized design, driving comfort, nimble, high cleaning efficiency;
- Powerful suction motor synchronous pumped sewage, ultraquiet design to reduce operator and noise impacts on the surrounding environment;
- Machines set up automatic and manual modes of operation, high efficiency and clean thoroughly.

## HY12 驾驶式洗地机

RIDE-ON SCRUBBER DRYER

产品尺寸 product size	1840x1106x1578mm	刷盘 quantity of brush	2x17寸
净重 net weight	715kg	洗地刷 brush diameter	17寸/432mm
清水箱容量 cleaning water tank volume	145L	吸扒宽度 squeegee width	1067mm
污水箱容量 sewage tank volume	150L	刷盘电机功率 washing brush power	2x480W
工作效率 working efficiency	8500m <sup>2</sup> /h	吸水电机功率 suction motor power	560W
系统供电 voltage	6VDCx6(36VDC)	行走电机功率 running motor power	650W

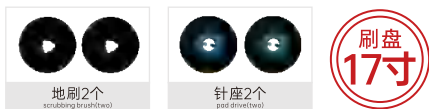

## HY16 洗扫一体机

ONE-PIECE CLEANING MACHINE

产品尺寸 product size	2120x1420x1673mm	刷盘直径 diameter of brush disc	2x878mm
净重 net weight	920kg	洗地刷 brush diameter	13寸/330mm
清水箱容量 cleaning water tank volume	240L	吸扒宽度 squeegee width	1067mm
污水箱容量 sewage tank volume	250L	刷盘电机功率 washing brush power	2x750W
工作效率 working efficiency	10000m <sup>2</sup> /h	吸水电机功率 suction motor power	2x560W
系统供电 voltage	6VDCx6(36VDC)	行走电机功率 running motor power	1000W



## HY55B 驾驶式洗地机

RIDE-ON SCRUBBER DRYER

包装尺寸 packing size	1450x660x1240mm	洗地刷转速 washing brush speed	155rpm
净重 net weight	212kg	洗地刷压力 washing brush pressure	30kg
毛重 gross weight	256kg	电压 voltage	24V DC
最大工作效率 maximum working efficiency	4850m <sup>2</sup> /h	刷盘电机功率 washing brush power	550W
吸水扒宽度 width of suction head	830mm	行车电机功率 running motor power	300W
工作宽度 working width	550mm	行车速度 running speed	0-5km/h
刷盘直径 brush diameter	22"	最大爬坡度 washing brush power	10°
吸水电机功率 suction motor power	500W	电瓶使用时间 working time	3-4hours
清水箱容量 cleaning water tank volume	80L	充电时间 charging time	8hours
污水箱容量 sewage tank volume	70L	电池 battery	12VDCx2



## HY75B 驾驶式洗地机

RIDE-ON SCRUBBER DRYER

包装尺寸 packing size	1640x890x1457mm	洗地刷转速 washing brush speed	155rpm
净重 net weight	377kg	洗地刷压力 washing brush pressure	38kg
毛重 gross weight	434kg	电压 voltage	24V DC
最大工作效率 maximum working efficiency	6000m <sup>2</sup> /h	刷盘电机功率 washing brush power	550Wx2
吸水扒宽度 width of suction head	980mm	行车电机功率 running motor power	400W
工作宽度 working width	750mm	行车速度 running speed	0-5km/h
刷盘直径 brush diameter	15"x2	最大爬坡度 washing brush power	10°
吸水电机功率 suction motor power	500W	电瓶使用时间 working time	3-4hours
清水箱容量 cleaning water tank volume	80L	充电时间 charging time	8hours
污水箱容量 sewage tank volume	100L	电池 battery	6Vx4



## HY75S 驾驶式洗地机

RIDE-ON SCRUBBER DRYER

包装尺寸 packing size	1640x890x1457mm	洗地刷转速 washing brush speed	155rpm
净重 net weight	331kg	洗地刷压力 washing brush pressure	38kg
毛重 gross weight	388kg	电压 voltage	24V DC
最大工作效率 maximum working efficiency	6000m <sup>2</sup> /h	刷盘电机功率 washing brush power	300Wx2
吸水扒宽度 width of suction head	1030mm	行车电机功率 running motor power	450W
工作宽度 working width	750mm	行车速度 running speed	0-5km/h
刷盘直径 brush diameter	15"x2	最大爬坡度 washing brush power	10°
吸水电机功率 suction motor power	500W	电瓶使用时间 working time	3-4hours
清水箱容量 cleaning water tank volume	80L	充电时间 charging time	8hours
污水箱容量 sewage tank volume	100L	电池 battery	6Vx4



# AUTOMATIC SCRUBBER

## 手推式洗地机



# 超宝手推式洗地机

## AUTOMATIC SCRUBBER

—  
**HY50B3**



工作宽度: **510mm**      最大工作效率: **2900m<sup>2</sup>/h**  
Working Width      Maximum Working Efficiency

·一步完成清洗地面和吸干污水两大任务,即洗即干  
·机器设备凭借紧凑设计的机身、友好的操作界面驾驶轻松可帮助物业保洁企业更好地节省成本、提高效率

·One step to finish floor cleaning and meanwhile vacuum the dirty water ,and make floor dry soon;  
·Delicate structure,simple interface and easy to operate.It is a good chdse for cleaning enterprise to save cost and do more efficient work.



### HY50B3 自动洗地吸干机

电瓶式 BATTERY TYPE AUTOMATIC SCRUBBER

包装尺寸 packing size	1150x660x1210mm	洗地刷转速 washing brush speed	155rpm
净重 net weight	130kg	洗地刷压力 washing brush pressure	22-36kg
毛重 gross weight	160kg	电压 voltage	24V DC
最大工作效率 maximum working efficiency	2900m <sup>2</sup> /h	刷盘电机功率 washing brush power	550W
吸水扒宽度 width of suction head	760mm	吸水电机功率 suction motor power	500W
工作宽度 working width	510mm	电瓶使用时间 working time	2.5-3.5hours
刷盘直径 brush diameter	20"	充电时间 charging time	8hours
清水箱容量 cleaning water tank volume	52L	电池 battery	12VDCx2
污水箱容量 sewage tank volume	45L		



### HY51B 自动洗地吸干机

电瓶式 BATTERY TYPE AUTOMATIC SCRUBBER

包装尺寸 packing size	1370x650x1230mm	洗地刷转速 washing brush speed	155rpm
净重 net weight	188.5kg	洗地刷压力 washing brush pressure	22-36kg
毛重 gross weight	220kg	电压 voltage	24V DC
最大工作效率 maximum working efficiency	2800m <sup>2</sup> /h	刷盘电机功率 washing brush power	550W
吸水扒宽度 width of suction head	760mm	吸水电机功率 suction motor power	400W
刷盘直径 brush diameter	20"	电瓶使用时间 working time	3-4hours
清水箱容量 cleaning water tank volume	48L	充电时间 charging time	8hours
污水箱容量 sewage tank volume	52L	电池 battery	12VDCx2



### HY51C 电线式洗地吸干机

SCRUBBER WITH CABLE

包装尺寸 packing size	1370x650x1230mm	洗地刷转速 washing brush speed	200rpm
净重 net weight	87kg	洗地刷压力 washing brush pressure	22-36kg
毛重 gross weight	124kg	电压 voltage	220VAC/50Hz
最大工作效率 maximum working efficiency	2600m <sup>2</sup> /h	刷盘电机功率 washing brush power	550W
吸水扒宽度 width of suction head	760mm	吸水电机功率 suction motor power	400W
清水箱容量 cleaning water tank volume	48L	刷盘直径 brush diameter	20"
污水箱容量 sewage tank volume	52L		



## HY2 电线式洗地吸干机

SCRUBBER WITH CABLE

包装尺寸 packing size	1050x610x1190mm	洗地刷转速 washing brush speed	175rpm
净重 net weight	76kg	洗地刷压力 washing brush pressure	25kg
毛重 gross weight	102kg	电压 voltage	220V~/50Hz
最大工作效率 maximum working efficiency	2000m <sup>2</sup> /h	刷盘电机功率 washing brush power	1200W
吸水扒宽度 width of suction head	760mm	吸水电机功率 suction motor power	400W
工作宽度 working width	457mm	电源线长度 length of power cord	18m
清水箱容量 cleaning water tank volume	30L	刷盘直径 brush diameter	18"
污水箱容量 sewage tank volume	30L		

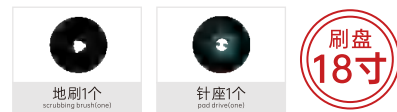

## HY46B 自动洗地吸干机

电瓶式 BATTERY TYPE AUTOMATIC SCRUBBER

包装尺寸 packing size	900x630x875mm	洗地刷转速 washing brush speed	155rpm
净重 net weight	103kg	洗地刷压力 washing brush pressure	25kg
毛重 gross weight	122.4kg	电压 voltage	24V DC
最大工作效率 maximum working efficiency	1500m <sup>2</sup> /h	刷盘电机功率 washing brush power	550W
吸水扒宽度 width of suction head	550mm	吸水电机功率 suction motor power	300W
工作宽度 working width	457mm	电瓶使用时间 charging time	2hours
刷盘直径 brush diameter	18"	充电时间 charging time	8hours
清水箱容量 cleaning water tank volume	22L	电池 battery	12VDCx2
污水箱容量 sewage tank volume	24L		



## HY45C 电线式洗地吸干机

SCRUBBER WITH CABLE

包装尺寸 packing size	1050x610x1190mm	洗地刷转速 washing brush speed	170rpm
净重 net weight	59kg	洗地刷压力 washing brush pressure	25kg
毛重 gross weight	88kg	电压 voltage	220VAC/50Hz
最大工作效率 maximum working efficiency	2000m <sup>2</sup> /h	刷盘电机功率 washing brush power	550W
吸水扒宽度 width of suction head	760mm	吸水电机功率 suction motor power	400W
工作宽度 working width	457mm	清水箱容量 cleaning water tank volume	33L
刷盘直径 brush diameter	18"	污水箱容量 sewage tank volume	31L



## HY46C 电线式洗地吸干机

电线式 CABLE TYPE SCRUBBER WITH CABLE

包装尺寸 packing size	900x630x875mm	洗地刷转速 washing brush speed	170rpm
净重 net weight	52kg	洗地刷压力 washing brush pressure	25kg
毛重 gross weight	71kg	电压 voltage	220VAC/50Hz
最大工作效率 maximum working efficiency	1350m <sup>2</sup> /h	刷盘电机功率 washing brush power	600W
吸水扒宽度 width of suction head	550mm	吸水电机功率 suction motor power	400W
工作宽度 working width	457mm	清水箱容量 cleaning water tank volume	22L
刷盘直径 brush diameter	18"	污水箱容量 sewage tank volume	24L



## HY45C-2 电线式洗地吸干机

SCRUBBER WITH CABLE

包装尺寸 packing size	1050x610x1190mm	洗地刷转速 washing brush speed	170rpm
净重 net weight	66kg	洗地刷压力 washing brush pressure	25kg
毛重 gross weight	95.7kg	电压 voltage	220VAC/50Hz
最大工作效率 maximum working efficiency	2000m <sup>2</sup> /h	刷盘电机功率 washing brush power	550W
吸水扒宽度 width of suction head	760mm	吸水电机功率 suction motor power	400W
工作宽度 working width	457mm	清水箱容量 cleaning water tank volume	33L
刷盘直径 brush diameter	18"	污水箱容量 sewage tank volume	31L



# SUPER ACE

## RIDE-ON SCRUBBER DRYER

### 超劲霸驾驶式洗地机 RIDE-ON SCRUBBER DRYER

- 驱动电机自动驱动，轻便省力
- 大容量双水箱，防堵防溢
- 多种场景适用，窄通道灵活转向，适配工业、公共、特殊场景清洁
- 超续航能力

- Automatic drive motor, lightweight and labor-saving
- Large capacity double water tank, anti-blocking and anti-overflow
- Multiple scenarios applicable flexible steering in narrow channels, suitable for industrial, public, and special scenario cleaning
- Super endurance capability



# SCRUBBER DRYER



机身储物/挂架

简化操作系统

霍尔加速器

双注水口

水箱容量标注

聚氨酯防滑轮毂

**SA600M(手动)** 单刷驾驶式洗地机  
RIDE-ON SCRUBBER DRYER

**SUPER ACE®**  
超劲霸

产品尺寸 product size	1560x1000x1190mm	刷盘压力 brush pressure	45kg
净重 net weight	230kg	刷盘直径 diameter of brush disc	22寸/700mm
毛重 Gross weight	245kg	刷地宽度 working width	600mm
方数 square number	1.5	吸扒宽度 squeegee width	1050mm
清水箱容量 cleaning water tank volume	85L	后驱电机功率 rear drive motor power	500W
污水箱容量 sewage tank volume	90L	刷盘电机功率 washing brush power	24V/500W
工作效率 working efficiency	6000m <sup>2</sup> /h	吸水电机功率 suction motor power	24V/400W
连续工作时间 working time	3-4hours	电压 voltage	24V/100A
电瓶充电时间 Battery charging time	6-8hours	电池 battery	100Ah



**SA660**  
**SA660M(手动)** 双刷驾驶式洗地机  
RIDE-ON SCRUBBER DRYER

**SUPER ACE®**  
超劲霸

产品尺寸 product size	1560x1000x1190mm	刷盘压力 brush pressure	45kg
净重 net weight	230kg	刷盘直径 diameter of brush disc	13寸/330mmx2
毛重 Gross weight	245kg	刷地宽度 working width	660mm
方数 square number	1.5	吸扒宽度 squeegee width	1050mm
清水箱容量 cleaning water tank volume	85L	后驱电机功率 rear drive motor power	500W
污水箱容量 sewage tank volume	90L	刷盘电机功率 washing brush power	24V/380Wx2
工作效率 working efficiency	6000m <sup>2</sup> /h	吸水电机功率 suction motor power	24V/400W
连续工作时间 working time	3-4hours	电压 voltage	24V/120A
电瓶充电时间 Battery charging time	6-8hours	电池 battery	120Ah



**SA860** 中型驾驶式洗地机  
RIDE-ON SCRUBBER DRYER

**SUPER ACE®**  
超劲霸

产品尺寸 product size	1740x870x1380mm	刷盘压力 brush pressure	30kg
净重 net weight	375kg	刷盘直径 diameter of brush disc	17寸/440mmx2
毛重 Gross weight	400kg	刷地宽度 working width	860mm
方数 square number	2.6	吸扒宽度 squeegee width	1150mm
清水箱容量 cleaning water tank volume	140L	后驱电机功率 rear drive motor power	600W
污水箱容量 sewage tank volume	150L	刷盘电机功率 washing brush power	24V/550Wx2
工作效率 working efficiency	8500m <sup>2</sup> /h	吸水电机功率 suction motor power	24V/400W
连续工作时间 working time	3-4hours	电压 voltage	24V/200A
电瓶充电时间 Battery charging time	6-8hours	电池 battery	200Ah



# SUPER ACE

## AUTOMATIC SCRUBBER



## 超劲霸手推式洗地机 AUTOMATIC SCRUBBER

- 驱动电机自动驱动，轻便省力
- 大容量双水箱，防堵防溢
- 多种场景适用，窄通道灵活转向，适配工业、公共、特殊场景清洁
- 超续航能力

- Automatic drive motor, lightweight and labor-saving
- Large capacity double water tank, anti-blocking and anti-overflow
- Multiple scenarios applicable flexible steering in narrow channels, suitable for industrial, public, and special scenario cleaning
- Super endurance capability



# AUTOMATIC SCRUBBER



简化操作系统



手推式行走开关



铸铝材质刷盘罩



聚氨酯防滑轮毂



水箱容量标注

## SA500

### 手推式洗地机 MANYAL SCRUBBER DRYER

**SUPER ACE®**  
超劲霸

产品尺寸 product size	1280x560x1120mm	刷盘压力 brush pressure	30-35kg
净重 net weight	145kg	刷盘直径 diameter of brush disc	19寸
毛重 Gross weight	173kg	刷地宽度 working width	500mm
方数 square number	1	吸扒宽度 squeegee width	800mm
清水箱容量 cleaning water tank volume	65L	后驱电机功率 rear drive motor power	/
污水箱容量 sewage tank volume	45L	刷盘电机功率 washing brush power	24V/550W
工作效率 working efficiency	2900m <sup>2</sup> /h	吸水电机功率 suction motor power	24V/400W
连续工作时间 working time	3-4hours	电压 voltage	24V/100A
电瓶充电时间 Battery charging time	6-8hours	电池 battery	100Ah



地刷1个  
scrubbing brush 1set



针座1个  
post 1set



刷盘  
19寸



## SA530

### 手推自走式洗地机 AUTOMATIC SCRUBBER DRYER

**SUPER ACE®**  
超劲霸

产品尺寸 product size	1370x630x1080mm	刷盘压力 brush pressure	30-35kg
净重 net weight	145kg	刷盘直径 diameter of brush disc	19寸
毛重 Gross weight	170kg	刷地宽度 working width	530mm
方数 square number	1	吸扒宽度 squeegee width	800mm
清水箱容量 cleaning water tank volume	60L	后驱电机功率 rear drive motor power	/
污水箱容量 sewage tank volume	65L	刷盘电机功率 washing brush power	24V/550W
工作效率 working efficiency	3000m <sup>2</sup> /h	吸水电机功率 suction motor power	24V/400W
连续工作时间 working time	3-4hours	电压 voltage	24V/100A
电瓶充电时间 Battery charging time	6-8hours	电池 battery	100Ah



地刷1个  
scrubbing brush 1set



针座1个  
post 1set



刷盘  
19寸



## SA530B

### 手推自走式洗地机 AUTOMATIC SCRUBBER DRYER

**SUPER ACE®**  
超劲霸

产品尺寸 product size	1370x630x1080mm	刷盘压力 brush pressure	30-35kg
净重 net weight	175kg	刷盘直径 diameter of brush disc	19寸
毛重 Gross weight	175kg	刷地宽度 working width	530mm
方数 square number	1	吸扒宽度 squeegee width	800mm
清水箱容量 cleaning water tank volume	60L	后驱电机功率 rear drive motor power	/
污水箱容量 sewage tank volume	65L	刷盘电机功率 washing brush power	24V/550W
工作效率 working efficiency	3000m <sup>2</sup> /h	吸水电机功率 suction motor power	24V/400W
连续工作时间 working time	3-4hours	电压 voltage	24V/100A
电瓶充电时间 Battery charging time	6-8hours	电池 battery	100Ah



地刷1个  
scrubbing brush 1set



针座1个  
post 1set



刷盘  
19寸



# LIGHTWEIGHT FLOOR SCRUBBER

## 轻便洗地机



### HYM1 轻便洗地机 LIGHTWEIGHT FLOOR SCRUBBER

产品尺寸 product size	518x377x1208mm	电压 voltage	24V
净重 net weight	24kg	电池 battery	12Ah
最大工作效率 maximum working efficiency	1200m <sup>2</sup> /h	刷盘电机功率 washing brush power	160W*2
洗地刷转速 washing brush speed	350rpm	吸水电机功率 suction motor power	120W
工作宽度 working width	520mm	电瓶使用时间 working time	1.5hours
清水箱容量 cleaning water tank volume	6L	污水箱容量 sewage tank volume	9L



### HYM3 轻便洗地机 LIGHTWEIGHT FLOOR SCRUBBER

产品尺寸 product size	584x401x1040mm	电压 voltage	24V
净重 net weight	20kg	电池 battery	12A
最大工作效率 maximum working efficiency	800m <sup>2</sup> /h	刷盘电机功率 washing brush power	200W
吸水扒宽度 width of suction head	340mm	吸水电机功率 suction motor power	120W
工作宽度 working width	280mm	电瓶使用时间 working time	1.5hours
清水箱容量 cleaning water tank volume	6L	污水箱容量 sewage tank volume	9L



### HYM5 轻便洗地机 LIGHTWEIGHT FLOOR SCRUBBER

产品尺寸 product size	720x450x1030mm	电压 voltage	24V
净重 net weight	60kg	电池 battery	2*12V 32AH
最大工作效率 maximum working efficiency	1000m <sup>2</sup> /h	刷盘电机功率 washing brush power	400W
吸水扒宽度 width of suction head	420mm	吸水电机功率 suction motor power	400W
工作宽度 working width	350mm	电瓶使用时间 working time	2hours
清水箱容量 cleaning water tank volume	13L	污水箱容量 sewage tank volume	15L



# SWEEPING MACHINE

## 扫地机



### HYS105 手推式扫地机

MANUAL SWEEPER

产品尺寸 product size	1300x790x1035mm	包装尺寸 packing size	890x810x390mm
容量 capacity	48L	重量 weight	23.8kg
工作宽度 operating width	1050mm	清扫速度 clearing efficiency	3680m <sup>2</sup> /h

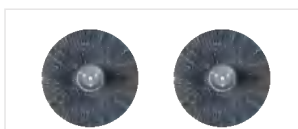

地刷2个  
scrubbing brush(two)



### CB-1400 驾驶式扫地机

DRIVING TYPE SWEEPING MACHINE

产品尺寸 product size	1920x1400x2000mm	主刷/边刷长度 length of main brush/edge brush	700mm/500mm
净重 net weight	600kg	驱动功率 driving power	2500W
爬坡度 climbing slope	35%	动力源 power source	48V
工作效率 working efficiency	10000m <sup>2</sup> /h	连续工作时间 continuous working time	4-6hours
清扫宽度 sweeping width	1400mm	垃圾箱容量 dustbin capacity	170L
转弯半径 turning radius	10km/h	过滤面积 filter area	6m <sup>2</sup>



大容量垃圾斗  
large capacity garbage bin

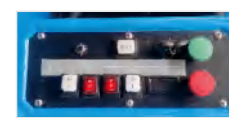

多功能集操控面板  
multi functional control panel



### CB-1900 驾驶式扫地机

DRIVING TYPE SWEEPING MACHINE

产品尺寸 product size	2400x1950x1900mm	主刷/边刷长度 length of main brush/edge brush	700mm/550mm
净重 net weight	700kg	驱动功率 driving power	2500W
爬坡度 climbing slope	35%	动力源 power source	48V
工作效率 working efficiency	19500m <sup>2</sup> /h	连续工作时间 continuous working time	5-7hours
清扫宽度 sweeping width	1950mm	垃圾箱容量 dustbin capacity	190L
最大行驶速度 maximum travel speed	12km/h	过滤面积 filter area	10m <sup>2</sup>

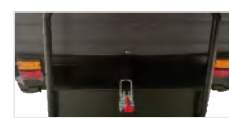

大容量垃圾斗  
large capacity garbage bin



专利前边刷升降伸缩臂  
patent front brush for lifting and retracting buttocks



## CB-1000

### 驾驶式扫地机

DRIVING TYPE SWEEPING MACHINE

产品尺寸 product size	1300x1000x980mm	水箱容量 tank capacity	40L
行驶速度 speed of travel	0-10km/h	驱动电机 drive motor	650W
爬坡度 climbing slope	15%	主刷电机 main brush motor	500W
清洁宽度 sweeping panths	1000mm	震尘电机 shock dust motor	60W
主刷宽度 main brush width	440mm	吸风电机 suction fan motor	200W
边刷直径*数量 brush diameter*number	400mm*2	边刷电机*数量 side brush motor*number	50W*2
工作效率 work efficiency	6800m <sup>2</sup> /h	噪音 noise	≤70dB
电瓶容量 battery capacity	48V 67Ah	整机重量 weight of the machine	240kg
工作时间 working hours	2-3h	灯光及信号 lights and signals	前大灯*1 警报灯*1
垃圾箱容量 trash can capacity	60L		



## CB-1350

### 驾驶式扫地机

DRIVING TYPE SWEEPING MACHINE

产品尺寸 product size	1650x1350x1200mm	水箱容量 tank capacity	50L*2
行驶速度 speed of travel	0-10km/h	驱动电机 drive motor	1000W
爬坡度 climbing slope	15%	主刷电机 main brush motor	700W
清洁宽度 sweeping panths	1350mm	震尘电机 shock dust motor	60W
主刷宽度 main brush width	590mm	吸风电机 suction fan motor	240W
边刷直径*数量 brush diameter*number	500mm*2	边刷电机*数量 side brush motor*number	90W*2
工作效率 work efficiency	10800m <sup>2</sup> /h	噪音 noise	≤70dB
电瓶容量 battery capacity	48V 67Ah	整机重量 weight of the machine	371kg
工作时间 working hours	2-3h	灯光及信号 lights and signals	前大灯*2 警报灯*1
垃圾箱容量 trash can capacity	120L		



## CB-1250

### 驾驶式扫地机

DRIVING TYPE SWEEPING MACHINE

产品尺寸 product size	1600x1250x1300mm	水箱容量 tank capacity	10L
行驶速度 speed of travel	0-10km/h	驱动电机 drive motor	1000W
爬坡度 climbing slope	15%	主刷电机 main brush motor	550W
清洁宽度 sweeping panths	1250mm	震尘电机 shock dust motor	/
主刷宽度 main brush width	490mm	吸风电机 suction fan motor	240W
边刷直径*数量 brush diameter*number	450mm*2	边刷电机*数量 side brush motor*number	90W*2
工作效率 work efficiency	8000m <sup>2</sup> /h	噪音 noise	≤70dB
电瓶容量 battery capacity	48V 67Ah	整机重量 weight of the machine	301kg
工作时间 working hours	2-3h	灯光及信号 lights and signals	前大灯*1 警报灯*1
垃圾箱容量 trash can capacity	80L		



## CB-1950

### 驾驶式扫地机

DRIVING TYPE SWEEPING MACHINE

产品尺寸 product size	2000x1950x1900mm	水箱容量 tank capacity	100L
行驶速度 speed of travel	0-10km/h	驱动电机 drive motor	1200W
爬坡度 climbing slope	15%	主刷电机 main brush motor	1000W
清洁宽度 sweeping panths	1950mm	震尘电机 shock dust motor	60W
主刷宽度 main brush width	690mm	吸风电机 suction fan motor	240W
边刷直径*数量 brush diameter*number	500mm*4	边刷电机*数量 side brush motor*number	90W*4
工作效率 work efficiency	15600m <sup>2</sup> /h	噪音 noise	≤70dB
电瓶容量 battery capacity	48V 103Ah	整机重量 weight of the machine	745kg
工作时间 working hours	2-3h	灯光及信号 lights and signals	前大灯*2 射灯*2 刹车灯*2
垃圾箱容量 trash can capacity	180L		





# 自动步梯清洁机

## ESCALATOR CLEANER

★ ★ ★  
步梯清洁  
明星产品  
★ ★ ★

### HY-450 自动步梯清洁机

ESCALATOR CLEANER

包装尺寸 packing size	945x550x315mm	电压 voltage	220VAC/50Hz
机身重量 net weight	38.5kg	滚刷电机功率 rolling brush motor	220W
工作宽度 working width	450mm	吸尘电机功率 power of vacuum motor	1000W
垃圾箱容量 dustbin capacity	10L		



### HY101 电动驾驶尘推车

ELECTRIC DRIVING DUST PUSH CART

包装尺寸 packing size	1100x510x490mm	转弯半径 turning radius	1100mm
产品尺寸 product size	1650x900x850mm	最大爬坡等级 maximum climbing grade	16%
总重量 total weight	58kg(含电池)	逾越障碍高度 beyond the bumper height	70mm
最高时速 maximum speed	9km/h	离地间隙 clearance above ground	90mm
满充行程 full power km	25km	充电器 charger	24V/2A
最大载重 maximum load	125kg	轮胎规格 tyre size	8寸实心胎
电机功率 motor power	230W	电池重量 battery weight	13kg
清扫宽度 sweeping width	900mm	驱动电机 rear drive motor	24V/350W



### HY102 电动驾驶尘推车

ELECTRIC DRIVING DUST PUSH CART

包装尺寸 packing size	1300x520x620mm	转弯半径 turning radius	1100mm
产品尺寸 product size	1450x900x1250mm	最大爬坡等级 maximum climbing grade	15%
总重量 total weight	60kg	逾越障碍高度 beyond the bumper height	100mm
最高时速 maximum speed	10km/h	驱动系统 driving system	48V-700W 正弦波矢量电机
满充行程 full power km	30-40km	充电器型号 charger model	48V12Ah(锂电池)
最大载重 maximum load	150kg	轮胎规格 tyre size	10寸充气轮胎
电机功率 motor power	500W	电池重量 battery weight	15kg
电瓶 battery	12V12Ah(3只)		





# 沙发机 SOFA MACHINE

## CB-1 小沙发机 SMALL SOFA MAINTAINER

包装尺寸 packing size	560x320x430mm	毛刷电机 brush motor	60W(24VDC)
电压 voltage	220V-240V-50/60Hz	毛刷直径 brush diameter	4.5"
气泵 air pump	20W	水箱容量 water tank capacity	8.5L
水泵 water pump	25W	重量 weight	15kg
产品特点 product features	制泡、刷洗		



标准配件  
standard fittings



## CB-2 大沙发机 LARGE SOFA MAINTAINER

包装尺寸 packing size	820x510x570mm	毛刷电机 brush motor	60W(24VDC)
电压 voltage	220V-240V-50/60Hz	毛刷直径 brush diameter	4.5"
真空电机 vacuum motor	1000W	清水箱容量 clean water tank capacity	6.5L
重量 weight	28kg	污水箱容量 dirty water tank capacity	4.5L
产品特点 product features	制泡、刷洗、吸干		



标准配件  
standard fittings



## CB-3 沙发机 SOFA MAINTAINER

包装尺寸 packing size	680x420x810mm	真空度 Vacuum degree	250mbar
吸水电机 suction motor	220V/50Hz/1600W	噪音 Noise	83dB
气泵 vacuum motor	220V/50Hz/20W	泡水箱容量 capacity of water tank	2.3L
喷水电机 weight	24V/30W	清水箱容量 clean water tank capacity	21L
产品特点 product features	制泡、刷洗、吸干		
		污水箱容量 dirty water tank capacity	30L



可选配件  
options



标准配件  
standard fittings



# CARPET WASHER

## 地毯抽洗机



### AC-20CS AC-30CS AC-802CS

#### 地毯抽洗机 CARPET WASHER

总功率 power	3110W	容量 capacity	20L/30L/80L
电压 voltage	220VAC/50Hz	真空吸力 vacuum suction	250mbar
桶身高度 height	970mm	气流量 air flow rate	106L/S
桶身直径 tank diameter	440mm	冷却模式 mode of cooling	循环风冷 circulating air cooling
配件直径 hose diameter	40mm	水泵 water sucking motor	220VAC/110W
大吸水扒宽度 big water sucker width	250mm	水泵压力 pressures	30PSL
小吸水扒宽度 little water sucker width	85mm		



新型全系列可更换水箱  
new type cistern



手提吸水扒  
suction steak



### AC-602CS 地毯抽洗机(双马达) CARPET WASHER(DUAL MOTOR)

### AC-603CS 地毯抽洗机(三马达) CARPET WASHER(THREE MOTOR)

总功率 power	2110W	容量 capacity	60L
电压 voltage	220VAC/50Hz	真空吸力 vacuum suction	250mbar
桶身高度 height	970mm	气流量 air flow rate	106L/S
桶身直径 tank diameter	440mm	冷却模式 mode of cooling	循环风冷 circulating air cooling
配件直径 hose diameter	40mm	水泵 water sucking motor	220VAC/110W
大吸水扒宽度 big water sucker width	250mm	水泵压力 pressures	30PSL
小吸水扒宽度 little water sucker width	85mm		



新型全系列可更换水箱  
new type cistern



手提吸水扒  
suction steak



### AC-602CP 地毯抽洗机(双马达) CARPET WASHER(DUAL MOTOR)

### AC-603CP 地毯抽洗机(三马达) CARPET WASHER(THREE MOTOR)

总功率 power	2110W	容量 capacity	60L
电压 voltage	220VAC/50Hz	真空吸力 vacuum suction	250mbar
桶身高度 height	970mm	气流量 air flow rate	106L/S
桶身直径 tank diameter	440mm	冷却模式 mode of cooling	循环风冷 circulating air cooling
配件直径 hose diameter	40mm	水泵 water sucking motor	220VAC/110W
大吸水扒宽度 big water sucker width	250mm	水泵压力 pressures	30PSL
小吸水扒宽度 little water sucker width	85mm		



新型全系列可更换水箱  
new type cistern



手提吸水扒  
suction steak



# THREE-IN-ONE CARPET WASHER

## 三合一地毯抽洗机



### DTJ2A 三合一地毯抽洗机 THREE-IN-ONE CARPET MACHINE

包装尺寸 packing size	1000x545x1975mm	吸水马达 suction motor	1000W
净重 net weight	46kg	压力 pressure	30PSI
毛重 gross weight	65kg	吸水扒宽度 water sucker	460mm
电压/频率 voltage/frequency	220VAC/50Hz	喷水马达 water spraying motor	110W
滚刷转速 rolling brush speed	1500rpm	清水箱容量 clean water tank capacity	25L
滚刷马达 rolling brush motor	180W	污水箱容量 dirty water tank capacity	36L
滚动宽度 rolling brush width	400mm	颜色 colour	● 蓝 blue ● 绿 green
真空度 vacuum	210mbar		



手提吸水扒  
suction stick



### HY31 三合一地毯抽洗机 THREE-IN-ONE CARPET MACHINE

包装尺寸 packing size	1110x550x945mm	吸水马达 suction motor	1000Wx2
净重 net weight	46.2kg	吸水扒宽度 water sucker	460mm
毛重 gross weight	65kg	吸力 suction	34kpa
电压/频率 voltage/frequency	220VAC/50Hz	水泵 water pumps	110W
滚刷转速 rolling brush speed	1400rpm	水压 water pressure	30PSI
滚刷马达 rolling brush motor	180W	清水箱容量 clean water tank capacity	21L
滚动宽度 rolling brush width	400mm	污水箱容量 dirty water tank capacity	38L
风量 air volume	335m³/h	颜色 colour	● 绿 green



手提吸水扒  
suction stick



### HY32 三合一地毯抽洗机 THREE-IN-ONE CARPET MACHINE

包装尺寸 packing size	1110x550x1030mm	吸水马达 suction motor	1500W
净重 net weight	55kg	吸水扒宽度 water sucker	455mm
毛重 gross weight	74kg	吸力 suction	24kpa
电压/频率 voltage/frequency	220VAC/50Hz	水泵 water pumps	100W
滚刷转速 rolling brush speed	800rpm	水压 water pressure	30PSI
滚刷马达 rolling brush motor	370W	清水箱容量 clean water tank capacity	29L
滚动宽度 rolling brush width	380mm	污水箱容量 dirty water tank capacity	29L
风量 air volume	300m³/h	颜色 colour	● 绿 green



手提吸水扒  
suction stick





## 吸尘吸水机 WET AND DRY VACUUM CLEANER



- 圆桶型不锈钢桶身，坚固耐用
- 配备强劲静音型马达，吸力特强
- 新型宽大轮盘座
- 稳重美观，随机附件一应俱全

- The stainless steel tank is strong and durable
- With a powerful lower-noise motor, the vacuum cleaner has a specially strong suction
- New-style large wheel plate
- It is stable and beautiful, a complete set of accessories are supplied with the vacuum cleaner

# BXC2A



## 静音型背式吸尘器 BACKPACK VACUUM CLEANER



- 外观时尚，设计合理、轻巧再配上吸力强劲的吸尘电机，使它能长时间不间断的工作
- 完美的背式设计，使操作者倍感舒适
- 无论在环境狭窄的小通道、管道、扶梯等均可使用
- 配有全套标准配件，方便高空或地面清洁使用适合于酒店、宾馆、办公室等场所

The backpack vacuum has fashionable appearance, reasonable design, light and handy, also with the stronger power vacuum dry motor, which also makes it have more durable working time. The perfect backpack design makes the user feel more comfortable and efficient when using. No matter in the narrow channel, pipelines, escalator or other places, you could use it to clean. And it matches the standard total set of accessories, to make it convenient to use for the high above the ground work or floor cleaning. It is suitable for the restaurant, hotel, and other work places, etc.

### 技术参数 Technical Specification

型号 Model	BXC2A
包装规格 Packing size	340x340x520mm
功能 Function	吸尘
容量 Capacity	3L
功率 Power	1000W
电压 Voltage	220V-50Hz/60Hz
真空吸力 Vacuum Suction	180mbar
空气流量 Air flow	42L/S



标准配件  
Standard fittings

## CB30 直立式吸尘器 CB30 UPRIGHT VACUUM CLEANER



标准配件  
Standard fittings



功能 function	吸尘 dry	噪音 noise	≤80db	真空度 vacuum degree	190mbar
容量 capacity	4.5L	转速 speed	300rpm	气流量 air flow rate	48L/S
吸尘电机功率 suction motor power	1200W	电压 voltage	220VAC/50Hz	净重 net weight	9.2kg
滚刷电机功率 rolling brush motor power	200W	毛重 gross weight	10.7kg	包装规格 packing size	847x335x215mm

## BXC3A 肩背式吸尘器 BXC3A BACKPACK VACUUM CLEANER



标准配件  
Standard fittings



功能 function	吸尘 dry	冷却模式 mode of cooling	循环风冷 circulating air cooling	真空吸力 vacuum suction	200mbar
容量 capacity	5L	电压 voltage	220V~50/60Hz	气流量 air flow rate	50L/S
功率 efficiency	1000W	包装规格 packing size	330x330x580mm		

# WET AND DRY VACUUM CLEANER

## 超劲霸吸尘吸水机



SUPER ACE®  
超劲霸

### 品牌介绍 BRAND INTRODUCTION

超劲霸(Super ACE)是超宝集团旗下的商业清洁设备品牌。其中,吸尘器是超劲霸的主打产品之一,包括车载吸尘器、干湿两用吸尘器、耐酸碱吸尘器,吸吹两用吸尘器等多种型号和功能。

这些吸尘器采用高效滤网和强劲的吸力,能够有效地清理地面上的尘埃、污渍和垃圾。

总的来说,超劲霸的商业清洁设备以高效、耐用、灵活等特点受到广泛好评,成为商业清洁行业的新星品牌。

Super ACE is a commercial cleaning equipment brand under the Superbao Group. Among them, the vacuum cleaner is one of the main products of SuperCE, including car vacuum cleaners, wet and dry vacuum cleaners, acid and alkali resistant vacuum cleaners, and vacuum cleaners with both suction and blowing functions. These vacuum cleaners equipped with efficient filters and powerful suction, which can effectively clean up dust, stains and garbage on the ground. In summary, Super ACE's commercial cleaning equipment is praised for its efficient, durable and flexible features, and has become a rising star brand in the commercial cleaning industry.

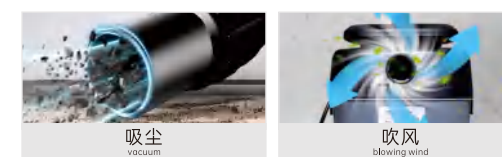

SA10  
超劲霸吸尘器



SA15  
超劲霸吸尘器



SA90  
超劲霸吸尘吸水机

#### 技术参数 Technical Specification

型号 Model	SA10	SA15	SA90
包装规格 Packing size	375x321x364mm	375x321x402mm	680x560x1010mm
功能 Function	吸尘	吸尘	吸尘吸水
容量 Capacity	10L	15L	90L
功率 Power	1000W	1000W	2000W/2400W/2800W/3200W
电压 Voltage	220V50Hz/60Hz	220V50Hz/60Hz	220V50Hz/60Hz
真空吸力 Vacuum Suction	230mbar	230mbar	200/225/245/265mbar
电线长度 Wire length	5m	5m	5m
颜色 Colour	● ●	● ●	/

# WET AND DRY VACUUM CLEANER

## 超劲宝吸尘吸水机



### 品牌介绍 BRAND INTRODUCTION

超劲宝(Super Power)是超宝集团旗下的商业清洁设备品牌。他们的产品包括吸尘器、洗地机、扫地机、蒸汽清洁机等。

超劲宝的产品主要由超宝加拿大设计总监JohnWilson亲自设计，具有多种功能和特点，例如人体工程学设计、方便收纳、高效去污、快速吸附、静音低噪、绿色低能耗等等。致力于不断研发出更加实用、节能、环保的清洁设备，以满足不同客户的需求。

超劲宝始终把产品质量放在首位，并提供优质的售后服务。产品已经出口到许多国家和地区，赢得了广泛的好评和信任。

Super Power is a commercial cleaning equipment brand under the Super Group. Their products include vacuum cleaners, floor scrubbers, sweeper machines, steam, etc. Super Power's products are mainly designed by John Wilson, the Canadian design director of Super Group, with a variety of functions and features, such as ergonomic, convenient storage, efficient dirt removal, quick suction, silent low noise, green low energy consumption, etc. Committed to continuously developing more practical, energy-saving and friendly cleaning equipment to meet the needs of different customers.

Super Power always puts product quality first and provides excellent after-sales service. The products have been exported to many countries and, winning widespread praise and trust.



马力调节  
power adjustable



SP101  
连体吸尘机



SP151  
连体吸尘吸水机



SP301  
连体吸尘吸水机

#### 技术参数 Technical Specification

型号 Model	SP101	SP151	SP301
电压 Voltage	220VAC/50Hz	220VAC/50Hz	220VAC/50Hz
功率 Power	1000/1200/1400/1600W	1000/1200/1400/1600W	1000/1200/1400/1600W
真空吸力 Vacuum Suction	190/200/220/240mbar	190/200/220/240mbar	190/200/220/240mbar
容量 Capacity	10L	15L	30L
桶身高度 Barrel height	235mm	280mm	480mm
桶身直径 Tank diameter	330mm	330mm	330mm
颜色 Colour	● ●	● ●	● ●

# WET AND DRY VACUUM CLEANER

## 超宝吸尘吸水机



### 品牌介绍 BRAND INTRODUCTION

超宝牌创立于1988年，是一个专业提供商业清洁用品的品牌，其产品涵盖了办公室、公共场所、酒店、商业中心等场所的各种清洁用品。

超宝牌的产品系列包括清洁剂、清洁工具、塑料制品、清洁设备这些产品均采用先进的科技和高质量的原材料制造而成，具有高效、环保、安全等特点。

与普通的清洁品牌不同，超宝牌对清洁效果和环保性要求更高。超宝牌定期进行技术改进和研发新产品，以不断满足客户不同的清洁需求。在市场上，超宝牌凭借高质量的产品、优质的服务和合理的价格，赢得了广大商业客户的信任和支持。品牌一直致力于为客户提供完善的清洁解决方案，帮助客户创造一个干净、舒适、安全的工作和生活环境。

ChaoBao brand was established in 1988, and it is a professional brand providing commercial cleaning products, covering a variety of products for office, public places, hotels, commercial centers, etc.

The product series of ChaoBao brand includes cleaning agents, cleaning tools, plastic products, cleaning equipment which are all manufactured with advanced technology and high-quality raw materials, and have the characteristics of high efficiency, environmental protection, and safety.

Unlike ordinary cleaning brands, ChaoBao brand has higher requirements for cleaning effect and environmental protection. ChaoBao brand regularly carries out technical improvements and develops new products to continuously meet the different cleaning needs of. In the market, ChaoBao brand has won the trust and support of the majority of commercial customers with high-quality products, high-quality services, and reasonable prices. The brand has always been committed to providing customers with complete cleaning solutions, helping customers create a clean, comfortable, and safe working and living environment.



CB101  
连体吸尘机

CB151  
连体吸尘吸水机

CB301  
连体吸尘吸水机

#### 技术参数 Technical Specification

型号 Model	CB101	CB151	CB301
电压 Voltage	220VAC/50Hz	220VAC/50Hz	220VAC/50Hz
功率 Power	1000/1200/1400/1600W	1000/1200/1400/1600W	1000/1200/1400/1600W
真空吸力 Vacuum Suction	190/200/220/240mbar	190/200/220/240mbar	190/200/220/240mbar
容量 Capacity	10L	15L	30L
桶身高度 Barrel height	235mm	280mm	480mm
桶身直径 Tank diameter	330mm	330mm	330mm
颜色 Colour	● ●	●	●

# WET AND DRY VACUUM CLEANER

## 超宝吸尘吸水机



### 品牌介绍 BRAND INTRODUCTION

超宝牌创立于1988年，是一个专业提供商业清洁用品的品牌，其产品涵盖了办公室、公共场所、酒店、商业中心等场所的各种清洁用品。

超宝牌的产品系列包括清洁剂、清洁工具、塑料制品、清洁设备这些产品均采用先进的科技和高质量的原材料制造而成，具有高效、环保、安全等特点。

与普通的清洁品牌不同，超宝牌对清洁效果和环保性要求更高。超宝牌定期进行技术改进和研发新产品，以不断满足客户不同的清洁需求。在市场上，超宝牌凭借高质量的产品、优质的服务和合理的价格，赢得了广大商业客户的信任和支持。品牌一直致力于为客户提供完善的清洁解决方案，帮助客户创建一个干净、舒适、安全的工作和生活环境。

ChaoBao brand was established in 1988, and it is a professional brand providing commercial cleaning products, covering a variety of products for office, public places, hotels, commercial centers, etc.

The product series of ChaoBao brand includes cleaning agents, cleaning tools, plastic products, cleaning equipment which are all manufactured with advanced technology and high-quality raw materials, and have the characteristics of high efficiency, environmental protection, and safety.

Unlike ordinary cleaning brands, ChaoBao brand has higher requirements for cleaning effect and environmental protection. ChaoBao brand regularly carries out technical improvements and develops new products to continuously meet the different cleaning needs of. In the market, ChaoBao brand has won the trust and support of the majority of commercial customers with high-quality products, high-quality services, and reasonable prices. The brand has always been committed to providing customers with complete cleaning solutions, helping customers create a clean, comfortable, and safe working and living environment.

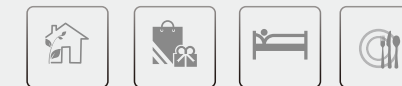

BF500  
不锈钢吸尘吸水机

BF501  
不锈钢吸尘吸水机

BF502  
不锈钢吸尘吸水机

BF593  
不锈钢吸尘吸水机

#### 技术参数 Technical Specification

型号 Model	BF500	BF501	BF502	BF593
电压 Voltage	220V50Hz/60Hz	220V50Hz/60Hz	220V50Hz/60Hz	220V50Hz/60Hz
功率 Power	1400W	1600W	2800W	2400/3000W
真空吸力 Vacuum Suction	230mbar	230mbar	230mbar	230mbar
容量 Capacity	15L	30L	70L	80L
可选配 Optional	1200/1600W	1200/1400W	2400W	2800/3200W

**CB15 不锈钢桶吸尘吸水机**

WET AND DRY VACUUM CLEANER (STAINLESS STEEL)

功率升级  
1400W

功能 function	吸尘吸水 wet and dry	冷却模式 mode of cooling	循环风冷 circulating air cooling
高度 height	55cm	桶身直径 tank diameter	345mm
容量 capacity	15L	配件直径 hose diameter	36mm
功率 efficiency	1400W	电压 voltage	220V-240V/50/60Hz
气流量 air flow rate	48L/S	真空吸力 vacuum suction	250mbar
可选配 optional	1200/1600W	包装规格 packing size	420x420x575mm
可选颜色 colour	● ● ●		



**CB60-2 不锈钢桶吸尘吸水机**

WET AND DRY VACUUM CLEANER (STAINLESS STEEL)

功率升级

功能 function	吸尘吸水 wet and dry	冷却模式 mode of cooling	循环风冷 circulating air cooling
高度 height	90cm	桶身直径 tank diameter	345mm
容量 capacity	60L	配件直径 hose diameter	40mm
功率 efficiency	2400/3000W	电压 voltage	220V-240V/50/60Hz
气流量 air flow rate	106L/S	真空吸力 vacuum suction	250mbar
可选配 optional	2600/2800/3200W	包装规格 packing size	590x520x955mm
可选颜色 colour	● ● ●		



**CB30 不锈钢桶吸尘吸水机**

WET AND DRY VACUUM CLEANER (STAINLESS STEEL)

功率升级  
1600W

功能 function	吸尘吸水 wet and dry	冷却模式 mode of cooling	循环风冷 circulating air cooling
高度 height	76cm	桶身直径 tank diameter	345mm
容量 capacity	30L	配件直径 hose diameter	36mm
功率 efficiency	1600W	电压 voltage	220V-240V/50/60Hz
气流量 air flow rate	53L/S	真空吸力 vacuum suction	230mbar
可选配 optional	1200/1400W	包装规格 packing size	430x430x575mm
可选颜色 colour	● ● ●		



**CB60-2J 不锈钢桶吸尘吸水机**

WET AND DRY VACUUM CLEANER (STAINLESS STEEL)

秋千架型  
功率升级

功能 function	吸尘吸水 wet and dry	冷却模式 mode of cooling	循环风冷 circulating air cooling
高度 height	90cm	桶身直径 tank diameter	345mm
容量 capacity	60L	配件直径 hose diameter	40mm
功率 efficiency	2400/3000W	电压 voltage	220V-240V/50/60Hz
气流量 air flow rate	106L/S	真空吸力 vacuum suction	250mbar
可选配 optional	2600/2800/3200W	包装规格 packing size	590x520x955mm
可选颜色 colour	● ● ●		



**CB30 不锈钢桶吸尘吸水机**

WET AND DRY VACUUM CLEANER (STAINLESS STEEL)

功率升级  
1600W

功能 function	吸尘吸水 wet and dry	冷却模式 mode of cooling	循环风冷 circulating air cooling
高度 height	76cm	桶身直径 tank diameter	345mm
容量 capacity	30L	配件直径 hose diameter	40mm
功率 efficiency	1600W	电压 voltage	220V-240V/50/60Hz
气流量 air flow rate	53L/S	真空吸力 vacuum suction	230mbar
可选配 optional	1200/1400W	包装规格 packing size	430x430x575mm
可选颜色 colour	● ● ●		



**CB80-2 不锈钢桶吸尘吸水机**

WET AND DRY VACUUM CLEANER (STAINLESS STEEL)

功率升级

功能 function	吸尘吸水 wet and dry	冷却模式 mode of cooling	循环风冷 circulating air cooling
高度 height	100cm	桶身直径 tank diameter	440mm
容量 capacity	80L	配件直径 hose diameter	40mm
功率 efficiency	2400/3000W	电压 voltage	220V-240V/50/60Hz
气流量 air flow rate	106L/S	真空吸力 vacuum suction	250mbar
可选配 optional	2600/2800/3200W	包装规格 packing size	590x520x1050mm
可选颜色 colour	● ● ●		



**CB80-2J 不锈钢桶吸尘吸水机**  
WET AND DRY VACUUM CLEANER (STAINLESS STEEL)

功率升级

**CB80-3J 不锈钢桶吸尘吸水机(3马达)**  
WET AND DRY VACUUM CLEANER (STAINLESS STEEL THREE-MOTOR)

功能 function	吸尘吸水 wet and dry	冷却模式 mode of cooling	循环风冷 circulating air cooling
高度 height	100cm	桶身直径 tank diameter	440mm
容量 capacity	80L	配件直径 hose diameter	40mm
功率 power	2400/3000W	电压 voltage	220V-240V/50/60Hz
气流量 air flow rate	106L/S	真空吸力 vacuum suction	250mbar
可选配 optional	2600/2800/3200W	包装规格 packing size	595x520x1105mm
可选颜色 colour	● ● ●		



**CB60-2BW 塑料桶吸尘吸水机**  
WET AND DRY VACUUM CLEANER (PLASTIC TANK)

功率升级

**CB60-3BW 塑料桶吸尘吸水机(3马达)**  
WET AND DRY VACUUM CLEANER (PLASTIC TANK THREE-MOTOR)

功能 function	吸尘吸水 wet and dry	冷却模式 mode of cooling	循环风冷 circulating air cooling
高度 height	90cm	桶身直径 tank diameter	440mm
容量 capacity	60L	配件直径 hose diameter	40mm
功率 power	2400/3000W	电压 voltage	220V-240V/50/60Hz
气流量 air flow rate	106L/S	真空吸力 vacuum suction	250mbar
可选配 optional	2600/2800/3200W	包装规格 packing size	730x600x1020mm
可选颜色 colour	● ● ●		

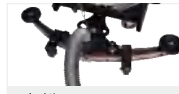

水扒 Floor nozzle



**CB60-2W 带扒式吸尘吸水机**  
WET AND DRY VACUUM CLEANER (WATER SUCKER)

功率升级

**CB60-3W 带扒式吸尘吸水机(3马达)**  
WET AND DRY VACUUM CLEANER (WATER SUCKER THREE-MOTOR)

功能 function	吸尘吸水 wet and dry	冷却模式 mode of cooling	循环风冷 circulating air cooling
高度 height	90cm	桶身直径 tank diameter	440mm
容量 capacity	60L	配件直径 hose diameter	40mm
功率 power	2400/3000W	电压 voltage	220V-240V/50/60Hz
气流量 air flow rate	106L/S	真空吸力 vacuum suction	250mbar
可选配 optional	2600/2800/3200W	包装规格 packing size	730x600x1020mm
可选颜色 colour	● ● ●		



水扒 Floor nozzle



**CB60-2B 塑料桶吸尘吸水机**  
WET AND DRY VACUUM CLEANER (PLASTIC TANK)

功率升级

**CB60-3B 塑料桶吸尘吸水机(3马达)**  
WET AND DRY VACUUM CLEANER (PLASTIC TANK THREE-MOTOR)

功能 function	吸尘吸水 wet and dry	冷却模式 mode of cooling	循环风冷 circulating air cooling
高度 height	90cm	桶身直径 tank diameter	440mm
容量 capacity	60L	配件直径 hose diameter	40mm
功率 power	2400/3000W	电压 voltage	220V-240V/50/60Hz
气流量 air flow rate	106L/S	真空吸力 vacuum suction	250mbar
可选配 optional	2600/2800/3200W	包装规格 packing size	590x520x955mm
可选颜色 colour	● ● ●		



**CB80-2W 不锈钢桶吸尘吸水机**  
WET AND DRY VACUUM CLEANER (STAINLESS STEEL)

功率升级

**CB80-3W 不锈钢桶吸尘吸水机(3马达)**  
WET AND DRY VACUUM CLEANER (STAINLESS STEEL THREE-MOTOR)

功能 function	吸尘吸水 wet and dry	冷却模式 mode of cooling	循环风冷 circulating air cooling
高度 height	100cm	桶身直径 tank diameter	440mm
容量 capacity	80L	配件直径 hose diameter	40mm
功率 power	2400/3000W	电压 voltage	220V-240V~
气流量 air flow rate	106L/S	真空吸力 vacuum suction	250mbar
可选配 optional	2600/2800/3200W	包装规格 packing size	730x600x1130mm
可选颜色 colour	● ● ●		



水扒 Floor nozzle



**CB90-2 塑料桶吸尘吸水机**  
WET AND DRY VACUUM CLEANER (PLASTIC TANK)

功率升级

**CB90-3 塑料桶吸尘吸水机(3马达)**  
WET AND DRY VACUUM CLEANER (PLASTIC TANK THREE-MOTOR)

功能 function	吸尘吸水 wet and dry	冷却模式 mode of cooling	循环风冷 circulating air cooling
高度 height	109cm	桶身直径 tank diameter	440mm
容量 capacity	90L	配件直径 hose diameter	40mm
功率 power	2400/3000W	电压 voltage	220V-240V/50/60Hz
气流量 air flow rate	106L/S	真空吸力 vacuum suction	250mbar
可选配 optional	2600/2800/3200W	包装规格 packing size	590x510x995mm
可选颜色 colour	● ● ●		



# WET AND DRY VACUUM CLEANER

## 超贝牌吸尘吸水机



CHAUBEI

### 品牌介绍 BRAND INTRODUCTION

超贝牌(CHAUBEI)是超宝集团旗下的商业清洁设备品牌,是针对商业场所清洁的专业设备。超贝牌商业清洁设备采用高效、耐用的清洁技术,能够快速而彻底地清洁商业场所内的各种清洁难题,提高卫生标准,创造更加舒适的工作或者生活环境。

除此之外,超贝牌商业清洁设备设计精良,使用方便,操作简单。采用智能化控制系统和高性能的电机,能够快速而节约地完成各种任务。这些设备的使用寿命长,不仅能够提高工作效率,还能够大大降低清洁成本。

CHAUBEI is a commercial cleaning equipment brand under the Chaobao Group, which is a professional equipment for cleaning commercial places. The cleaning equipment of Chaobei brand adopts efficient and durable cleaning technology, which can quickly and thoroughly clean various cleaning problems in commercial places, improve health standards, and create a more comfortable or living environment.

In addition, the commercial cleaning equipment of Chaobei brand is well designed, easy to use, and simple to operate. With intelligent control system and high-performance motor, it can quickly and save various tasks. The service life of these equipment is long, which can not only improve work efficiency but also greatly reduce cleaning costs.



CH15N  
不锈钢桶吸尘吸水机  
(普通底座)



CH30N  
不锈钢桶吸尘吸水机  
(普通底座)



秋千架型  
CH602J  
CH603J(三马达)  
不锈钢桶吸尘吸水机

#### 技术参数 Technical Specification

型号 Model	CH15N	CH30N	CH602J/CH603J
包装规格 Packing size	410x410x610mm	410x410x765mm	590x525x970mm
功能 Function	吸尘吸水	吸尘吸水	吸尘吸水
冷却模式 Mode of cooling	循环风冷	循环风冷	循环风冷
容量 Capacity	15L	30L	60L
电压 Voltage	220-240V/50/60Hz	220-240V/50/60Hz	220-240V/50/60Hz
功率 Power	1400W	1600W	2400/3000W
桶身高度 Barrel height	550mm	760mm	900mm
桶身直径 Tank diameter	345mm	345mm	440mm
气流量 Air flow rate	48L/S	53L/S	106L/S
真空吸力 Vacuum Suction	210mbar	210mbar	250mbar
配件直径 Hose diameter	40mm	40mm	40mm
可选配 Optional	/	1200/1400W	2600/2800/3200W
颜色 Colour	● ●	● ●	● ●

### CH15H 不锈钢桶吸尘吸水机

豪华底座 LUXURY BASE WET AND DRY VACUUM CLEANER(STAINLESS STEEL)

功能 function	吸尘吸水 wet and dry	冷却模式 mode of cooling	循环风冷 circulating air cooling
高度 height	55cm	桶身直径 tank diameter	345mm
容量 capacity	15L	配件直径 hose diameter	36mm
功率 efficiency	1400W	电压 voltage	220V-240V/50/60Hz
气流量 air flow rate	48L/S	真空吸力 vacuum suction	210mbar
可选配 optional	1200/1600W	包装规格 packing size	410x410x600mm
可选颜色 colour	● ●		



功率升级

### CH15B 塑料桶吸尘吸水机

WET AND DRY VACUUM CLEANER(PLASTIC STEEL)

功能 function	吸尘吸水 wet and dry	冷却模式 mode of cooling	循环风冷 circulating air cooling
高度 height	55cm	桶身直径 tank diameter	345mm
容量 capacity	15L	配件直径 hose diameter	36mm
功率 efficiency	2400/3000W	电压 voltage	220V-240V/50/60Hz
气流量 air flow rate	48L/S	真空吸力 vacuum suction	210mbar
可选配 optional	1200/1600W	包装规格 packing size	410x410x600mm
可选颜色 colour	● ●		



功率升级

### CH30H 不锈钢桶吸尘吸水机

豪华底座 LUXURY BASE WET AND DRY VACUUM CLEANER(STAINLESS STEEL)

功能 function	吸尘吸水 wet and dry	冷却模式 mode of cooling	循环风冷 circulating air cooling
高度 height	76cm	桶身直径 tank diameter	345mm
容量 capacity	30L	配件直径 hose diameter	40mm
功率 efficiency	1600W	电压 voltage	220V-240V/50/60Hz
气流量 air flow rate	53L/S	真空吸力 vacuum suction	210mbar
可选配 optional	1200/1400W	包装规格 packing size	410x410x780mm
可选颜色 colour	● ●		



功率升级

### CH602B 塑料桶吸尘吸水机

WET AND DRY VACUUM CLEANER(PLASTIC STEEL)

### CH603B 塑料桶吸尘吸水机(3马达)

WET AND DRY VACUUM CLEANER(PLASTIC STEEL)

功能 function	吸尘吸水 wet and dry	冷却模式 mode of cooling	循环风冷 circulating air cooling
高度 height	90cm	桶身直径 tank diameter	440mm
容量 capacity	60L	配件直径 hose diameter	40mm
功率 efficiency	2400/3000W	电压 voltage	220V-240V/50/60Hz
气流量 air flow rate	106L/S	真空吸力 vacuum suction	250mbar
可选配 optional	2600/2800/3200W	包装规格 packing size	590x525x970mm
可选颜色 colour	● ●		



功率升级

### CH602 不锈钢桶吸尘吸水机

WET AND DRY VACUUM CLEANER(STAINLESS STEEL)

### CH603 不锈钢桶吸尘吸水机(3马达)

WET AND DRY VACUUM CLEANER(STAINLESS STEEL THREE-MOTOR)

功能 function	吸尘吸水 wet and dry	冷却模式 mode of cooling	循环风冷 circulating air cooling
高度 height	90cm	桶身直径 tank diameter	440mm
容量 capacity	60L	配件直径 hose diameter	40mm
功率 efficiency	2400/3000W	电压 voltage	220V-240V/50/60Hz
气流量 air flow rate	106L/S	真空吸力 vacuum suction	250mbar
可选配 optional	2600/2800/3200W	包装规格 packing size	590x525x970mm
可选颜色 colour	● ●		



功率升级

### CH902B 塑料桶吸尘吸水机

WET AND DRY VACUUM CLEANER(PLASTIC STEEL)

### CH903B 塑料桶吸尘吸水机(3马达)

WET AND DRY VACUUM CLEANER(PLASTIC STEEL)

功能 function	吸尘吸水 wet and dry	冷却模式 mode of cooling	循环风冷 circulating air cooling
高度 height	90cm	桶身直径 tank diameter	440mm
容量 capacity	90L	配件直径 hose diameter	40mm
功率 efficiency	2400/3000W	电压 voltage	220V-240V/50/60Hz
气流量 air flow rate	106L/S	真空吸力 vacuum suction	250mbar
可选配 optional	2600/2800/3200W	包装规格 packing size	590x510x950mm
可选颜色 colour	● ●		



功率升级

## CH802

### 不锈钢桶吸尘吸水机

WET AND DRY VACUUM CLEANER (STAINLESS STEEL)

功率升级

## CH803

### 不锈钢桶吸尘吸水机(3马达)

WET AND DRY VACUUM CLEANER (STAINLESS STEEL THREE-MOTOR)

功能 function	吸尘吸水 wet and dry	冷却模式 mode of cooling	循环风冷 circulating air cooling
高度 height	100cm	桶身直径 tank diameter	440mm
容量 capacity	80L	配件直径 hose diameter	40mm
功率 power	2400/3000W	电压 voltage	220V-240V/50/60Hz
气流量 air flow rate	106L/S	真空吸力 vacuum suction	250mbar
可选配 optional	1200/1600W	包装规格 packing size	590x525x1020mm
可选颜色 colour	● ●		



## CH802J

### 不锈钢桶吸尘吸水机

WET AND DRY VACUUM CLEANER (STAINLESS STEEL)

功率升级

## CH803J

### 不锈钢桶吸尘吸水机(3马达)

WET AND DRY VACUUM CLEANER (STAINLESS STEEL THREE-MOTOR)

功能 function	吸尘吸水 wet and dry	冷却模式 mode of cooling	循环风冷 circulating air cooling
高度 height	100cm	桶身直径 tank diameter	440mm
容量 capacity	80L	配件直径 hose diameter	40mm
功率 power	2400/3000W	电压 voltage	220V-240V/50/60Hz
气流量 air flow rate	106L/S	真空吸力 vacuum suction	250mbar
可选配 optional	1200/1600W	包装规格 packing size	590x525x1060mm
可选颜色 colour	● ●		



## CH60-B2F CB60-B2F

### 前扒式吸尘吸水机

WET AND DRY VACUUM CLEANER (WATER SCRAPER)

功率升级

功能 function	吸尘吸水 wet and dry	冷却模式 mode of cooling	循环风冷 circulating air cooling
高度 height	100cm	桶身直径 tank diameter	440mm
容量 capacity	80L	配件直径 hose diameter	40mm
功率 power	800W	电压 voltage	240VDC
气流量 air flow rate	106L/S	真空吸力 vacuum suction	250mbar
包装规格 packing size	970x670x1080mm	可选颜色 colour	● ●



电池 Battery





# 超静音吸尘器

## SUPPER LOWER-NOISE DRY VACUUM CLEANER



### 技术参数 Technical Specification

型号 Model	AC-101
包装规格 Packing size	380x380x460mm
功能 Function	吸尘
冷却模式 Mode of cooling	循环风冷
容量 Capacity	10L
电压 Voltage	220-240V/50/60Hz
功率 Power	1000W
桶身高度 Barrel height	320mm
桶身直径 Tank diameter	345mm
气流量 Air flow rate	48L/S
真空吸力 Vacuum Suction	210mbar
配件直径 Hose diameter	36mm
可选配 Optional	/
颜色 Colour	● ●

### AC101 超静音吸尘器

#### SUPPER LOWER-NOISE DRY VACUUM CLEANER

外观设计超前时尚  
吸力强劲的进口吸尘电机使它得以长时间不间断操作  
完美的隔音设计，最能适应对噪音敏感区域的清洁

It has a fashionable appearance  
The imported vacuum motor, which has a strong suction, allows a long and uninterrupted operation  
The perfect sound insulation design makes it suitable for noise sensitive site



AC101



超前时尚设计 进口吸尘电机 完美隔音设计

Advanced fashionable design  
Imported dust collection motor  
Perfect sound-proof design



# WET AND DRY VACUUM CLEANER

## 星空洁吸尘吸水机



### 品牌介绍 BRAND INTRODUCTION

星空洁牌(AIR CLEAN)是超宝集团旗下的商业清洁设备品牌,是针对商业场所清洁的专业设备。星空洁牌商业清洁设备以“绿色环保”为产品设计的第一理念,能够快速而彻底地清洁商业场所内的各种清洁难题,提高卫生标准,创造更加舒适的工作或者生活环境。

除此之外,星空洁牌商业清洁设备设计精良,使用方便,操作简单。采用智能化控制系统和高性能的电机,能够快速而节约地完成各种任务。这些设备的使用寿命长,不仅能够提高工作效率,还能够大大降低清洁成本。

AIR CLEAN is a commercial cleaning equipment brand under the Superbao Group, specializing in professional equipment for cleaning commercial places. The AIR CLEAN cleaning equipment adheres to the first concept of "green and environmental protection" in product design, and can quickly and thoroughly solve various cleaning problems in commercial places, improve health standards and create a more comfortable working or living environment.

In addition, the AIR CLEAN commercial cleaning equipment is well-designed, easy to use, and simple to operate. With control systems and high-performance motors, it can quickly and efficiently complete various tasks. The lifespan of these equipment is long, which not only improves work efficiency but also greatly reduces cleaning.



AC-151  
不锈钢桶吸尘吸水机



AC-301  
不锈钢桶吸尘吸水机



AC-602J  
AC-602J-3(三马达)  
不锈钢桶吸尘吸水机

#### 技术参数 Technical Specification

型号 Model	AC-151	AC-301	AC-602J/AC-602J-3
包装规格 Packing size	410x410x615mm	410x410x800mm	590x525x1035mm
功能 Function	吸尘吸水	吸尘吸水	吸尘吸水
冷却模式 Mode of cooling	循环风冷	循环风冷	循环风冷
容量 Capacity	15L	30L	60L
电压 Voltage	220-240V/50/60Hz	220-240V/50/60Hz	220-240V/50/60Hz
功率 Power	1400W	2400/3000W	2400/3000W
桶身高度 Barrel height	580mm	780mm	970mm
桶身直径 Tank diameter	345mm	345mm	440mm
气流量 Air flow rate	48L/S	53L/S	106L/S
真空吸力 Vacuum Suction	210mbar	210mbar	250mbar
配件直径 Hose diameter	36mm	40mm	40mm
可选配 Optional	/	1200/1600W	1200/1600W
颜色 Colour	●	●	●

**AC-802J****不锈钢桶吸尘吸水机**

WET AND DRY VACUUM CLEANER (STAINLESS STEEL)

**功率升级****AC-802J-3****不锈钢桶吸尘吸水机(3马达)**

WET AND DRY VACUUM CLEANER (STAINLESS STEEL THREE-MOTOR)

功能 function	吸尘吸水 wet and dry	冷却模式 mode of cooling	循环风冷 circulating air cooling
高度 height	107cm	桶身直径 tank diameter	440mm
容量 capacity	80L	配件直径 hose diameter	40mm
功率 efficiency	2400/3000W	电压 voltage	220V-240V/50/60Hz
气流量 air flow rate	106L/S	真空吸力 vacuum suction	250mbar
可选配 optional	2600/2800W	包装规格 packing size	590x525x1130mm
可选颜色 colour	●		

**AC603W****带扒式吸尘吸水机**

WET AND DRY VACUUM CLEANER (WATER SUCKER)

**功率升级****AC603W-3****带扒式吸尘吸水机(3马达)**

WET AND DRY VACUUM CLEANER (WATER SUCKER THREE-MOTOR)

功能 function	吸尘吸水 wet and dry	冷却模式 mode of cooling	循环风冷 circulating air cooling
高度 height	97cm	桶身直径 tank diameter	440mm
容量 capacity	60L	配件直径 hose diameter	40mm
功率 efficiency	2400/3000W	电压 voltage	220V-240V/50/60Hz
气流量 air flow rate	106L/S	真空吸力 vacuum suction	250mbar
可选配 optional	1200/1600W	包装规格 packing size	730x600x1020mm
可选颜色 colour	●		



水扒 Floor nozzle

**AC60-2W****不锈钢桶吸尘吸水机**

WET AND DRY VACUUM CLEANER (STAINLESS STEEL)

**功率升级****AC60-2W****不锈钢桶吸尘吸水机(3马达)**

WET AND DRY VACUUM CLEANER (STAINLESS STEEL THREE-MOTOR)

功能 function	吸尘吸水 wet and dry	冷却模式 mode of cooling	循环风冷 circulating air cooling
高度 height	107cm	桶身直径 tank diameter	440mm
容量 capacity	60L	配件直径 hose diameter	40mm
功率 efficiency	2400/3000W	电压 voltage	220V-240V/50/60Hz
气流量 air flow rate	106L/S	真空吸力 vacuum suction	250mbar
可选配 optional	1200/1600W	包装规格 packing size	730x600x1020mm
可选颜色 colour	●		



水扒 Floor nozzle

**AC-603J****塑料桶吸尘吸水机**

WET AND DRY VACUUM CLEANER (PLASTIC TANK)

**功率升级****AC-603J-3****塑料桶吸尘吸水机(3马达)**

WET AND DRY VACUUM CLEANER (PLASTIC TANK THREE-MOTOR)

功能 function	吸尘吸水 wet and dry	冷却模式 mode of cooling	循环风冷 circulating air cooling
高度 height	87cm	桶身直径 tank diameter	440mm
容量 capacity	60L	配件直径 hose diameter	40mm
功率 efficiency	2400/3000W	电压 voltage	220V-240V/50/60Hz
气流量 air flow rate	106L/S	真空吸力 vacuum suction	250mbar
可选配 optional	1200/1600W	包装规格 packing size	590x520x965mm
可选颜色 colour	●		

**AC80-2W****不锈钢桶吸尘吸水机**

WET AND DRY VACUUM CLEANER (STAINLESS STEEL)

**功率升级****AC80-3W****不锈钢桶吸尘吸水机(3马达)**

WET AND DRY VACUUM CLEANER (STAINLESS STEEL THREE-MOTOR)

功能 function	吸尘吸水 wet and dry	冷却模式 mode of cooling	循环风冷 circulating air cooling
高度 height	107cm	桶身直径 tank diameter	440mm
容量 capacity	80L	配件直径 hose diameter	40mm
功率 efficiency	2400/3000W	电压 voltage	220V-240V/50/60Hz
气流量 air flow rate	106L/S	真空吸力 vacuum suction	250mbar
可选配 optional	1200/1600W	包装规格 packing size	730x600x1160mm
可选颜色 colour	●		



水扒 Floor nozzle

**AC-604****塑料桶吸尘吸水机**

WET AND DRY VACUUM CLEANER (PLASTIC TANK)

**功率升级****AC-604-3****塑料桶吸尘吸水机(3马达)**

WET AND DRY VACUUM CLEANER (PLASTIC TANK THREE-MOTOR)

功能 function	吸尘吸水 wet and dry	冷却模式 mode of cooling	循环风冷 circulating air cooling
高度 height	109cm	桶身直径 tank diameter	440mm
容量 capacity	90L	配件直径 hose diameter	40mm
功率 efficiency	2400/3000W	电压 voltage	220V-240V/50/60Hz
气流量 air flow rate	106L/S	真空吸力 vacuum suction	250mbar
可选配 optional	1200/1600W	包装规格 packing size	590x510x995mm
可选颜色 colour	●		





# 刷地机 BRUSHING MACHINE

# BRUSHING MACHINE



# BRUSHING MACHINE

## 154系列刷地机



### 技术参数 Technical Specification

型号 Model	<b>HY005</b>
电压 Voltage	220V-50Hz
功率 Power	1200W
转速 Speed	154rpm
底盘直径 Base plate diameter	17"

### 标准配件 Standard fittings



机器具有操作方便，使用安全，清洁效果优良等突出的优点。特别适用于宾馆、酒店、办公大楼、展览馆等大型公共场所清洁地毯、地板和各种地面低速抛光及石材晶面翻新。清洁效率高，可以大大节省清洁工作的时间，是现代机械清洁工作不可缺少的重要设备。

The machine features convenient operation, safe use and excellent cleaning effect. It is especially suitable for cleaning the carpet, floor, low speed polishing for various types of floor and refitting of stone surface for hotels, restaurants, office buildings and exhibition halls. The product boasts high cleaning efficiency and can greatly save the time of cleaning, being a necessary and important equipment for modern mechanical cleaning work.



蝴蝶手柄

功率: **1200W**  
Power

转速: **154rpm**  
Speed

**HY005**



- 手柄操作方便，可长时间使用
- 采用原装进口技术，专门偏心式设计，使重量与离心力平衡
- 中心输水，减少清洁剂的损耗，提高清洁效率
- 行星齿采用高密度耐磨尼龙钢制造，从而噪音低，使用寿命长
- 底盘采用优质铝合金制造，坚固耐用
- 特别适用于宾馆、酒店、办公大楼、展览馆等大型公共场所清洁地毯、地板和各种地面低速抛光及石材晶面翻新
- Ergonomic handle for easy operation and long-term use
- Utilizes original imported technology with a dedicated eccentric design that balances weight and central force
- Central water delivery to reduce the loss of cleaning agent and improve cleaning efficiency
- Planetary gears made of high-density wear-resistant nylon steel for low noise long service life
- Chassis made of high-quality aluminum alloy for durability
- Particularly suitable for cleaning carpets, floors, and various ground surfaces in large public places as hotels, office buildings, exhibition venues, etc., as well as low-speed polishing and marble surface restoration

# A-005

多功能刷地机  
Multi-functional  
Brushing Machine



技术参数 Technical Specification

电压 voltage	220V-50Hz
功率 power	1200W
转速 speed	154rpm
底盘直径 base plate diameter	17"

标准配件 Standard Fittings



# A-005T

多功能刷地机  
Multi-functional  
Brushing Machine



技术参数 Technical Specification

电压 voltage	220V-50Hz
功率 power	1200W
转速 speed	154rpm
底盘直径 base plate diameter	17"

标准配件 Standard Fittings



# A-003

多功能刷地机  
Multi-functional  
Brushing Machine



技术参数 Technical Specification

电压 voltage	220V-50Hz
功率 power	1200W
转速 speed	154rpm
底盘直径 base plate diameter	17"

标准配件 Standard Fittings



# GH003

多功能刷地机  
Multi-functional  
Brushing Machine



技术参数 Technical Specification

电压 voltage	220V-50Hz
功率 power	1200W
转速 speed	154rpm
底盘直径 base plate diameter	17"

标准配件 Standard Fittings



# GH005

多功能刷地机  
Multi-functional  
Brushing Machine



技术参数 Technical Specification

电压 voltage	220V-50Hz
功率 power	1200W
转速 speed	154rpm
底盘直径 base plate diameter	17"

标准配件 Standard Fittings



# AC-171

多功能刷地机  
Multi-functional  
Brushing Machine



技术参数 Technical Specification

电压 voltage	220V-50Hz
功率 power	1200W
转速 speed	154rpm
底盘直径 base plate diameter	17"

标准配件 Standard Fittings



# A-003B

多功能刷地机  
Multi-functional  
Brushing Machine



技术参数 Technical Specification

电压 voltage	220V-50Hz
功率 power	1200W
转速 speed	154rpm
底盘直径 base plate diameter	17"

标准配件 Standard Fittings



# BRUSHING MACHINE

## 175系列刷地机



### 技术参数 Technical Specification

型号 Model	<b>HY002</b>
电压 Voltage	220V-50Hz
功率 Power	1200W
转速 Speed	175rpm
底盘直径 Base plate diameter	17"

### 标准配件 Standard fittings



蝴蝶手柄

功率: **1200W**  
Power

转速: **175rpm**  
Speed

**HY002**



机器具有操作方便, 使用安全, 清洁效果优良等突出的优点。特别适用于宾馆、酒店、办公大楼、展览馆等大型公共场所清洁地毯、地板和各种地面低速抛光及石材晶面翻新。清洁效率高, 可以大大节省清洁工作的时间, 是现代机械清洁工作不可缺少的重要设备。

The machine features convenient operation, safe use and excellent cleaning effect. It is especially suitable for cleaning the carpet, floor, low speed polishing for various types of floor and refitting of stone surface for hotels, restaurants, office buildings and exhibition halls. The product boasts high cleaning efficiency and can greatly save the time of cleaning, being a necessary and important equipment for modern mechanical cleaning work.

- 机器具有操作方便, 使用安全, 清洁效果优良等突出的优点
- 特别适用于宾馆、酒店、办公大楼、展览馆等大型公共场所清洁地毯、地板和各种地面低速抛光及石材晶面翻新
- 清洁效率高, 可以大大节省清洁工作的时间, 是现代机械清洁工作不可缺少的重要设备

- The machine features convenient operation, safe use and excellent cleaning effect
- It is especially suitable for cleaning the carpet, floor, low speed polishing for various types of floor and refitting of stone surface for hotels, restaurants, office buildings and exhibition halls
- The product boasts high cleaning efficiency and can greatly save the time of cleaning, being a necessary and important equipment for modern mechanical cleaning work

# A-002

多功能刷地机  
Multi-functional  
Brushing Machine



技术参数 Technical Specification

电压 voltage	220V-50Hz
功率 power	1200W
转速 speed	175rpm
底盘直径 base plate diameter	17"

标准配件 Standard Fittings



# A-002T

多功能刷地机  
Multi-functional  
Brushing Machine



技术参数 Technical Specification

电压 voltage	220V-50Hz
功率 power	1200W
转速 speed	175rpm
底盘直径 base plate diameter	17"

标准配件 Standard Fittings



# SA001 SUPER ACE® 超劲霸

多功能刷地机  
Multi-functional  
Brushing Machine



技术参数 Technical Specification

电压 voltage	220V-50/60Hz
功率 power	1200W
转速 speed	175rpm
底盘直径 base plate diameter	17"

标准配件 Standard Fittings



# HY038

多功能刷地机  
Multi-functional  
Brushing Machine



技术参数 Technical Specification

电压 voltage	220V-50Hz
功率 power	1200W
转速 speed	175rpm
底盘直径 base plate diameter	18"

标准配件 Standard Fittings



# GH002

多功能刷地机  
Multi-functional  
Brushing Machine



技术参数 Technical Specification

电压 voltage	220V-50/60Hz
功率 power	1200W
转速 speed	175rpm
底盘直径 base plate diameter	17"

标准配件 Standard Fittings



# A-007

多功能刷地机  
Multi-functional  
Brushing Machine



技术参数 Technical Specification

电压 voltage	220V-50Hz
功率 power	1200W
转速 speed	175rpm
底盘直径 base plate diameter	17"

标准配件 Standard Fittings



# HY039

多功能刷地机  
Multi-functional  
Brushing Machine



技术参数 Technical Specification

电压 voltage	220V-50Hz
功率 power	1200W
转速 speed	175rpm
底盘直径 base plate diameter	18"

标准配件 Standard Fittings



# HY039T

多功能刷地机  
Multi-functional  
Brushing Machine



技术参数 Technical Specification

电压 voltage	220V-50Hz
功率 power	1200W
转速 speed	175rpm
底盘直径 base plate diameter	18"

标准配件 Standard Fittings



# HY5A

多功能刷地机  
Multi-functional  
Brushing Machine



技术参数 Technical Specification

电压 voltage	220V-50Hz
功率 power	1200W
转速 speed	175rpm
底盘直径 base plate diameter	17"

标准配件 Standard Fittings



# HY5B

多功能刷地机  
Multi-functional  
Brushing Machine



技术参数 Technical Specification

电压 voltage	220V-50Hz
功率 power	1200W
转速 speed	175rpm
底盘直径 base plate diameter	18"

标准配件 Standard Fittings



# HY7A

多功能刷地机  
Multi-functional  
Brushing Machine



技术参数 Technical Specification

电压 voltage	220V-50Hz
功率 power	1200W
转速 speed	175rpm
底盘直径 base plate diameter	17"

标准配件 Standard Fittings



# CB-171

多功能刷地机  
Multi-functional  
Brushing Machine



技术参数 Technical Specification

电压 voltage	220V-50Hz
功率 power	1500W
转速 speed	175rpm
底盘直径 base plate diameter	17"

标准配件 Standard Fittings



# HY6A

多功能刷地机  
Multi-functional  
Brushing Machine



技术参数 Technical Specification

电压 voltage	220V-50/60Hz
功率 power	1200W
转速 speed	175rpm
底盘直径 base plate diameter	17"

标准配件 Standard Fittings



# HY6B

多功能刷地机  
Multi-functional  
Brushing Machine



技术参数 Technical Specification

电压 voltage	220V-50Hz
功率 power	1200W
转速 speed	175rpm
底盘直径 base plate diameter	18"

标准配件 Standard Fittings



# HY1A

多功能偏头刷地机  
Multi-functional  
Brushing Machine



技术参数 Technical Specification

电压 voltage	220V-50Hz
功率 power	1200W
转速 speed	175rpm
底盘直径 base plate diameter	17"

标准配件 Standard Fittings



# HY2A

多功能刷地机  
Multi-functional  
Brushing Machine



技术参数 Technical Specification

电压 voltage	220V-50Hz
功率 power	1200W
转速 speed	175rpm
底盘直径 base plate diameter	17"

标准配件 Standard Fittings



# BRUSHING MACHINE

## 迷你型多功能刷地机



### CB-130标准配件 Standard Fittings



·多功能集成高效清洁，集地面清洗、地毯清洁、起蜡、抛光于一体，8升水箱减少加水频次，适配多材质场景，清洁效率高

·紧凑轻便适配性强，30kg轻量化机身搭配13寸底盘，轻松穿梭狭窄空间，220V电压兼顾商用与家用场景，操作门槛低

·可靠耐用性价比优，双电容电机故障率低，享1年质保与快速售后，价格仅为进口机型70%，无故障运行时长久

·Multi-functional Integration for Efficient Cleaning: Integrates floor cleaning, carpet cleaning, wax removal and polishing. The 8L water tank reduces refilling frequency, adapts to multi-material scenarios, and ensures high cleaning efficiency.

·Compact, Lightweight and Highly Adaptable: With a 30kg lightweight body and 13-inch base, it moves easily in narrow spaces. The 220V voltage suits both commercial and household use, with low operation threshold.

·Reliable, Durable and Cost-Effective: The dual-capacitor motor has a low failure rate. It comes with a 1-year warranty and fast after-sales service, costs only 70% of imported models, and has a long trouble-free operation time.

## CB-130

### 迷你型多功能刷地机 Multi-functional Brushing Machine



#### 技术参数 Technical Specification

电压 voltage	220V-50Hz
功率 power	550W
转速 speed	154rpm
刷盘直径 brush plate diameter	13"



### HY130标准配件 STANDARD FITTINGS



#### 技术参数 Technical Specification

电压 voltage	220V-50Hz
功率 power	750W
转速 speed	175rpm
刷盘直径 brush plate diameter	13"



## HY130

### 迷你型多功能刷地机 Multi-functional Brushing Machine

·功能多元实用，集洗地、洗地毯、起蜡、低速磨光于一体，适配多场景清洁需求，无需频繁换设备。

·操作省力高效，手控式设计搭配齿轮传动与双电容配置，动力强劲，8升水箱加持，清洁轻松又高效。

·品质扎实耐用，采用原厂电机与优质塑料制造，底盘带防撞胶圈，机身稳重且坚固耐磨，适配商用场景。

·Versatile and Practical Functions: Integrates floor cleaning, carpet cleaning, wax removal and low-speed polishing, meeting multi-scenario cleaning needs without frequent equipment replacement.

·Effort-saving and Efficient Operation: Features a hand-controlled design with gear transmission and dual-capacitor configuration, boasting strong power and an 8L water tank for easy and efficient cleaning.

·Solid and Durable Quality: Made of original motors and high-quality plastics, with anti-collision rubber rings on the chassis, ensuring a stable, sturdy and wear-resistant body suitable for commercial scenarios.

# BRUSHING MACHINE

## 加重翻新机系列



### 技术参数 Technical Specification

型号 Model	<b>HYA1</b>
电压 Voltage	220V-50Hz
功率 Power	2.5HP
转速 Speed	176rpm
底盘直径 Base plate diameter	18"(460mm)

### 标准配件 Standard fittings



功率: **2.5HP**  
Power

转速: **176rpm**  
Speed

- 特大功率风冷式,双电容配置,工作更安全可靠
- 强劲动力输出
- 集清洗地毯、地面、起蜡、低速抛光等多功能于一身

· It is super high power air-cooling motor and the double-capacitor design allow a safer operation

· It provides a strong power output

· It has multiple functions such as carpet and floor cleaning, wax removing, low-speed polishing, floor cry stall treatment and renewing



机器具有操作方便,使用安全,清洁效果优良等突出的优点。特别适用于宾馆、酒店、办公大楼、展览馆等大型公共场所清洁地毯、地板和各种地面低速抛光及石材晶面翻新。清洁效率高,可以大大节省清洁工作的时间,是现代机械清洁工作不可缺少的重要设备。

The machine features convenient operation, safe use and excellent cleaning effect. It is especially suitable for cleaning the carpet, floor, low speed polishing for various types of floor and refitting of stone surface for hotels, restaurants, office buildings and exhibition halls. The product boasts high cleaning efficiency and can greatly save the time of cleaning, being a necessary and important equipment for modern mechanical cleaning work.

**HYA1**



# A-004

**加重翻新机**  
Disk Weighing  
renewing Machine



技术参数 Technical Specification

电压 voltage	220V-50Hz
功率 power	1500W
转速 speed	154rpm
底盘直径 base plate diameter	17"
颜色 colour	● ● ●

标准配件 Standard Fittings



# HY004

**加重翻新机**  
Disk Weighing  
renewing Machine



技术参数 Technical Specification

电压 voltage	220V-50Hz
功率 power	1500W
转速 speed	154rpm
底盘直径 base plate diameter	17"
颜色 colour	● ● ●

标准配件 Standard Fittings



# HY168T

**加重翻新机**  
Disk Weighing  
renewing Machine



技术参数 Technical Specification

电压 voltage	220V-50Hz
功率 power	1800W
转速 speed	175rpm
底盘直径 base plate diameter	18"

标准配件 Standard Fittings



# CB-168T

**加重翻新机**  
Disk Weighing  
renewing Machine



技术参数 Technical Specification

电压 voltage	220V-50Hz
功率 power	1500W
转速 speed	168rpm
底盘直径 base plate diameter	17"

标准配件 Standard Fittings



# HY3A

**石材加重翻新机**  
Stone Disk Weighing  
renewing Machine



技术参数 Technical Specification

电压 voltage	220V-50Hz
功率 power	1800W
转速 speed	170rpm
底盘直径 base plate diameter	18"
电流 current	6.6A
噪音 noise	≤54dB

标准配件 Standard Fittings



# HY4A

**石材加重翻新机**  
Stone Disk Weighing  
renewing Machine



技术参数 Technical Specification

电压 voltage	220V-50Hz
功率 power	2200W
转速 speed	150rpm
底盘直径 base plate diameter	18"
电流 current	13.6A
噪音 noise	≤54dB

标准配件 Standard Fittings



# A-205

**手电钻式抛光机**  
Electric Hand Drill  
Polishing Machine



技术参数 Technical Specification

包装 packing	4台/箱
功率 power	1050W
转速 speed	1000-3000rpm/min
转盘直径 rotor plate diameter	7"

# PW1

**电动喷雾器**  
Electric Spary



技术参数 Technical Specification

包装尺寸 packing size	500x210x320mm
功率 power	1200W
电压/频率 power	220V-50Hz

# BRUSHING MACHINE

## 高速抛光机



- 专为大面积场地设计，20升大容量水箱配合角落清扫功能，单次作业覆盖范围更广
- 立式人体工学设计，30千克机身兼顾稳定与操控，缺水警报功能避免干磨损伤设备
- 1800W输出，可适配瓷砖、大理石、实木地板等多种材质的抛光需求

- Designed for large areas, the 20L large-capacity water tank, combined with the corner cleaning function, covers a wider range of work operation
- Vertical ergonomic design, 30kg body takes into account stability and control, and the water shortage alarm function avoids dry grinding damage to equipment
- 1800W output, can meet the polishing needs of various materials such as tiles, marble, solid wood floors, etc.



刷盘  
20寸

#### 技术参数 Technical Specification

电压 voltage	220V-50Hz
功率 power	1800W
转速 speed	1500rpm
刷盘直径 brush plate diameter	20"

## HY1500C

### 高速抛光机 High-Speed Burning

刷盘  
20寸



#### 技术参数 Technical Specification

电压 voltage	220V-50Hz
功率 power	1800W
转速 speed	1500rpm
刷盘直径 brush plate diameter	20"

## A-010

### 高速抛光机 High-Speed Burning

- 1500转/分钟高速运行系统，打蜡后抛光快速光亮，日常保养可实现“一喷一磨”即时复亮
- 手控式调节手柄搭配多方向操作系统，新手易掌握，狭窄空间也能精准控制抛光
- 全封闭风冷式马达散热好，高精度传动结构运行稳，可高频次长时间连续作业
- 适配石材、木地板、地砖等材质，覆盖家庭、商用、工业等多场景的抛光养护需求

- 1500 rpm high-speed operation system, quick and bright polishing after waxing, daily maintenance can achieve "one spray and one grind to restore luster instantly"
- Hand-controlled adjustment handle with multi-directional operation system, easy to master for beginners, and precise control of polishing in narrow spaces
- Full enclosed air-cooled motor with good heat dissipation, high-precision transmission structure with stable operation, can work continuously for a long time at high frequency
- Compatible stone, wooden floors, tiles and other materials, covering the polishing and maintenance needs of family, commercial, industrial and other scenarios

# ELECTRIC INTELLIGENT CLEANING BRUSH

## 电动智能清洁刷



- 多刷头适配清洁全面，配备圆刷、扁刷等可替换刷头，能深入瓷砖缝隙、窗台边角等死角，兼顾平面与缝隙清洁
- 轻污用低速省能耗，重污开高速强效去污，适配不同场景清洁需求
- 机身可直接冲洗清洁，浴室、厨房等潮湿环境使用无漏电隐患
- Multi-brush head adapter for comprehensive cleaning, equipped with round brush, flat brush and other replaceable brush heads, which can deeply clean the dead corners as the gap between tiles and the edge of the windowsill, and take into account the cleaning of both flat and gap surfaces
- Low speed for light dirt to save energy consumption high speed for heavy dirt to effectively remove stains, suitable for different scenarios of cleaning needs
- The body can be directly washed and cleaned, and there is no risk of electric leakage used in damp environments such as bathrooms and kitchens



### 技术参数 Technical Specification

产品尺寸 product size	15.8x6.3x12.2cm
包装尺寸 packing size	18.5x13.5x6.5cm
工作时间 endurance	60分钟
功率 power	30W



## CBI-001

### 电动智能清洁刷

Electric Intelligent Cleaning Brush



### 技术参数 Technical Specification

产品尺寸 product size	74x74x135cm(主机+加长杆)
包装尺寸 packing size	43x20x18.5cm
工作时间 endurance	150分钟
转速 speed	400转/分

## CBI-002

### 迷你电动智能清洁刷

Mini Electric Intelligent Cleaning Brush

- 无线续航满足大范围清洁，内置大容量锂电池，满电可连续工作60分钟，摆脱电源线束缚，轻松覆盖全屋清洁
- 弧形手柄贴合掌心握持角度，清洁高处或地面时无需弯腰发力，长时间使用不易累
- 运行噪音低至55分贝，清洁时不会产生刺耳声响，适合家庭、办公室等需要安静环境的场景

- Wireless endurance meets extensive cleaning, built-in large capacity lithium battery, can work continuously for 60 minutes when fully charged, free from the constraints power cords, easily covering the entire house cleaning
- Arc-shaped handle fits the palm of the hand grip angle, no need to bend down and exert force when cleaning high or the ground, not easy to get tired with long-term use
- Operation noise is as low as 55 decibels, no harsh sound will be generated during, suitable for home, office and other scenarios that need a quiet environment

# 3-SPEED BLOWER

## 吹风机



### CB-135S 三速吹风机

负离子/吹风/定时

3-SPEED BLOWER

包装规格 packing size	330x290x260mm
功率 efficiency	135W
电压 voltage	220V-50Hz
风量 air flow rate	13/12/11.5m <sup>3</sup> /min
转速档位 rotation speed	高/中/低 high/medium/low



### CB-135B 三速吹风机

3-SPEED BLOWER

包装规格 packing size	330x290x260mm
功率 efficiency	135W
电压 voltage	220V-50Hz
风量 air flow rate	13/12/11.5m <sup>3</sup> /min
转速档位 rotation speed	高/中/低 high/medium/low



### CB-135C 三速吹风机

3-SPEED BLOWER

包装规格 packing size	330x290x260mm
功率 efficiency	135W
电压 voltage	220V-50Hz
风量 air flow rate	13/12/11.5m <sup>3</sup> /min
转速档位 rotation speed	高/中/低 high/medium/low



### CB-200 三速吹风机

3-SPEED BLOWER

包装规格 packing size	330x300x375mm
功率 efficiency	200W
电压 voltage	220V-50Hz
风量 air flow rate	15.3/14.1/11.5m <sup>3</sup> /min
转速档位 rotation speed	高/中/低 high/medium/low
颜色 colour	● ●



**CB-350  
CB-350N** 三速吹风机  
3-SPEED BLOWER

包装规格 packing size	400x370x326mm
功率 efficiency	350W
电压 voltage	220V-50Hz
风量 air flow rate	12.5/11.5/10.5m³/min
转速档位 rotation speed	高/中/低 high/medium/low
颜色 colour	● ●



**CB-900C** 三速吹风机  
3-SPEED BLOWER

包装规格 packing size	530x420x600mm
功率 efficiency	1000W
电压 voltage	220V-50Hz
风量 air flow rate	160/130/110m³/min
转速档位 rotation speed	高/中/低 high/medium/low
颜色 colour	● ●



**CB-900N** 三速吹风机  
3-SPEED BLOWER

包装规格 packing size	530x420x600mm
功率 efficiency	1000W
电压 voltage	220V-50Hz
风量 air flow rate	160/130/110m³/min
转速档位 rotation speed	高/中/低 high/medium/low
颜色 colour	● ●



**CB-900D** 三速吹风机  
3-SPEED BLOWER

包装规格 packing size	530x420x600mm
功率 efficiency	1000W
电压 voltage	220V-50Hz
风量 air flow rate	160/130/110m³/min
转速档位 rotation speed	高/中/低 high/medium/low
颜色 colour	● ●



**CB-900** 三速吹风机  
3-SPEED BLOWER

包装规格 packing size	580x410x610mm
功率 efficiency	1000W
电压 voltage	220V-50Hz
风量 air flow rate	160/130/110m³/min
转速档位 rotation speed	高/中/低 high/medium/low
颜色 colour	● ●



**CB-900E** 三速吹风机  
3-SPEED BLOWER

包装规格 packing size	530x420x600mm
功率 efficiency	1000W
电压 voltage	220V-50Hz
风量 air flow rate	160/130/110m³/min
转速档位 rotation speed	高/中/低 high/medium/low
颜色 colour	● ●



CB-900E全新可折叠式设计  
New super position type design

**CB-900B** 三速吹风机  
3-SPEED BLOWER

包装规格 packing size	530x420x600mm
功率 efficiency	1000W
电压 voltage	220V-50Hz
风量 air flow rate	160/130/110m³/min
转速档位 rotation speed	高/中/低 high/medium/low
颜色 colour	● ●



**CB-900R** 三速吹风机  
3-SPEED BLOWER

包装规格 packing size	530x420x600mm
功率 efficiency	1000W(冷)-3000(热)
电压 voltage	220V-50Hz
风量 air flow rate	160/130/110m³/min
转速档位 rotation speed	高/中/低 high/medium/low
颜色 colour	●



### 154洗地刷(正面)

154 FLOOR BRUSH(FRONT SIDE)



型号 Model	产品尺寸 Product Size
A-071A18	18"
A-071A	17"
A-071A13	13"

### 154地毯刷(正面)

154 CARPET BRUSH(FRONT SIDE)



型号 Model	产品尺寸 Product Size
A-071B18	18"
A-071B	17"
A-071B13	13"

### 175洗地刷(正面)

175 FLOOR BRUSH(FRONT SIDE)



型号 Model	产品尺寸 Product Size
A-072A18	18"
A-072A	17"

### 175地毯刷(正面)

175 CARPET BRUSH(FRONT SIDE)



型号 Model	产品尺寸 Product Size
A-072B18	18"
A-072B	17"

### 154针座

154 PAD HOLDER



型号 Model	产品尺寸 Product Size
A-071C18	18"
A-071C	17"

### 175针座

175 PAD HOLDER



型号 Model	产品尺寸 Product Size
A-072C18	18"
A-072C	17"

### 154带动盘

154 DRIVING PLATE



型号 Model	产品尺寸 Product Size
A-071D18	18"
A-071D	17"

### 175带动盘

175 DRIVING PLATE



型号 Model	产品尺寸 Product Size
A-072D18	18"
A-072D	17"

抛光盘

BRUNISH PLATE



型号 Model	产品尺寸 Product Size
A-073	20"

175卡扣 18寸翻新打磨带动盘  
(HYA1/HY168T/HY3A)



型号 Model	产品尺寸 Product Size
A-073D18	18"

HY4A专用无敌扣 18寸翻新打磨带动盘



型号 Model	产品尺寸 Product Size
A-074D18	18"

磨片

POLISH MAT



C-102



C-199

型号 Model	说明 Description	产品尺寸 Product size	包装规格 Packing
C-102	钻石打磨碟	50#/150#/300#/500#/800#/1000#/1500#/2000#/3000#	6片/盒 6PCS/CTN
C-199	17"抛光磨棉纱垫	/	/

百亮牌

BAILIANG



C-103



C-104

型号 Model	说明 Description	产品尺寸 Product size	包装尺寸 Packing size	包装规格 Packing
C-103	百亮牌抛光钢丝垫	0#/1#/2#/3#	40x40x62cm	20片/箱 20PCS/CTN
C-104	百亮牌抛光钢丝球	0#/1#/2#/3#	66x39x39cm	100个/箱 100PCS/CTN

超宝牌

CHAobao



C-103



C-104

型号 Model	说明 Description	产品尺寸 Product size	包装尺寸 Packing size	包装规格 Packing
C-103	超宝牌抛光钢丝垫	0#/1#/2#/3#	40x40x62cm	20片/箱 20PCS/CTN
C-104	超宝牌抛光钢丝球	0#/1#/2#/3#	66x39x39cm	100个/箱 100PCS/CTN

### 超宝百洁垫白色

FLOOR PAD MADE IN CHINA

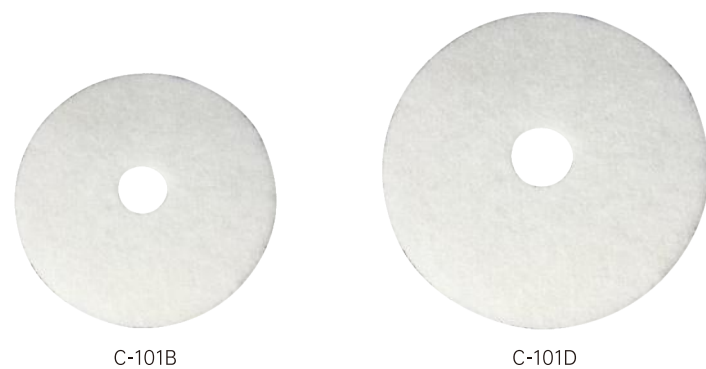

C-101B

C-101D

型号 Model	产品尺寸 Product size	颜色 Colour	包装规格 Packing
C-101B	17"	白色	5片/箱 5PCS/CTN
C-101D	20"	白色	5片/箱 5PCS/CTN

### 超宝百洁垫红色

FLOOR PAD MADE IN CHINA

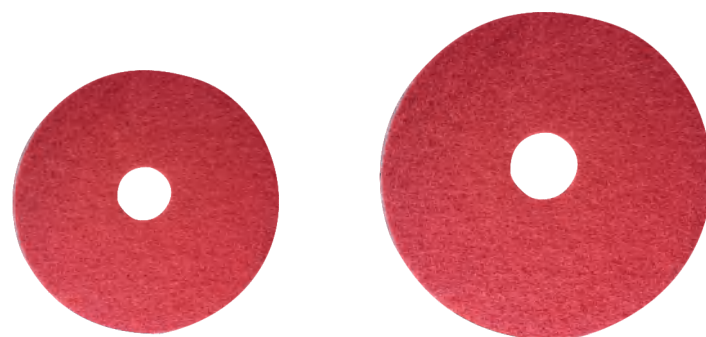

C-101B

C-101D

型号 Model	产品尺寸 Product size	颜色 Colour	包装规格 Packing
C-101B	17"	红色	5片/箱 5PCS/CTN
C-101D	20"	红色	5片/箱 5PCS/CTN

### 超宝百洁垫黑色

FLOOR PAD MADE IN CHINA

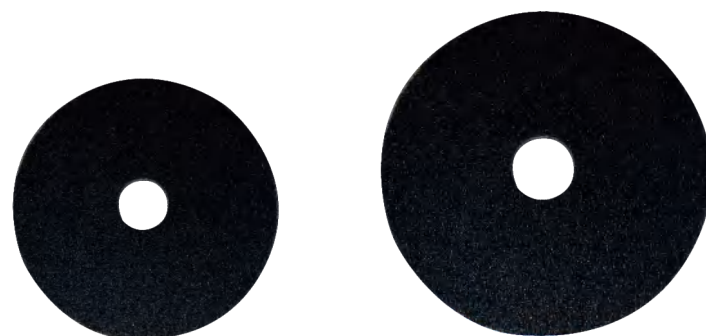

C-101B

C-101D

型号 Model	产品尺寸 Product size	颜色 Colour	包装规格 Packing
C-101B	17"	黑色	5片/箱 5PCS/CTN
C-101D	20"	黑色	5片/箱 5PCS/CTN

### 15升吸尘吸水机配件

15L WET AND DRY VACUUM CLEANER ACCESSORIES

- 1、直钢管 straight steeltube
- 2、圆毛刷 round brush
- 3、尘扒 dust vacuuming head
- 4、水扒 water vacuuming head
- 5、沙发扒头 sofa vacuuming head
- 6、长扁扒 long flat vacuuming head
- 7、软管 soft tube
- 8、短接头 short connector
- 9、长接头 long connector

注：15升单吸尘机不配吸水扒  
Note: 15L dust only vacuum cleaner doesn't include water vacuuming head

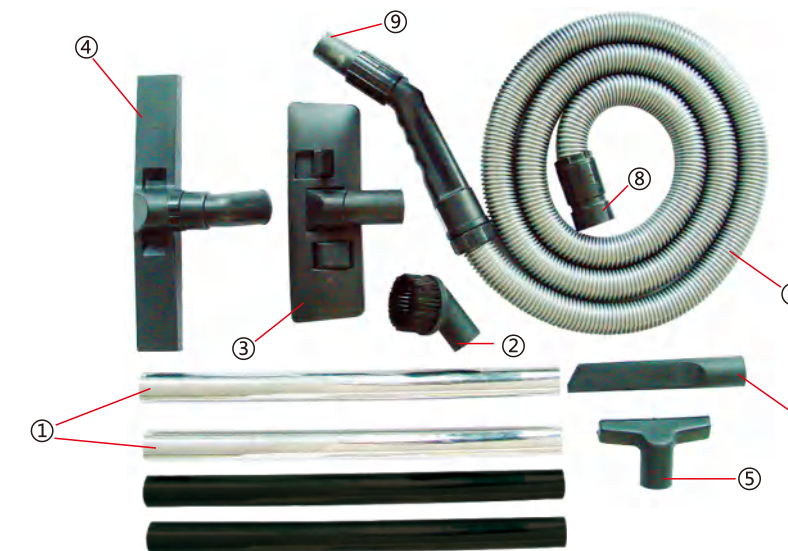

注：塑料管为15升、30升塑料桶吸尘吸水机专用  
Note: The plastic tube is specially used by 15L/30L plastic tank vacuum

型号 Model	说明 Description
A-056A	15升吸尘吸水机配件 15L WET AND DRY VACUUM CLEANER ACCESSORIES

### 30升/60升/80升/90升吸尘吸水机配件

30L/60L/80L/90L WET AND DRY VACUUM CLEANER ACCESSORIES

- 1、弯钢管 Bent Steel Tube
- 2、圆毛刷 Round Brush
- 3、尘扒 Dust Vacuuming Head
- 4、水扒 Water Vacuuming Head
- 5、长扁扒 Long Flat Vacuuming Head
- 6、软管 Soft Tube
- 7、长接头 Long Connector
- 8、短接头 Short Connector



型号 Model	说明 Description
A-056B	30升/60升/80升/90升吸尘吸水机配件 30L/60L/80L/90L WET AND DRY VACUUM CLEANER ACCESSORIES

### 尘袋&滤芯

DUST BAG & FILTER ELEMENT

欢迎客户来样特殊订造  
Orders with samples are welcome



型号 Model	说明 Description	容量 Capacity
A-070	海帕干湿滤芯 Hypa dry and wet filter element	/
A-066	AC-101尘袋 Dust bag	/
A-068	吸尘袋 Dust bag	5L/10L

### 尘隔

DUST TRAP



型号 Model	说明 Description
A-064	15L/30L吸尘器尘隔
A-065	30L吸尘器尘隔
A-067	60L以上吸尘器尘隔
A-069	60L以上吸尘器尘隔

### 配件

ACCESSORIES



型号 Model	说明 Description	产品尺寸 Product size
A-088	吸尘吸水机吸扒 Rear Suction	
C-018	地毯吸水钢扒 Carpet Water Steel Sucker	管径3.8cm

### 吸水扒胶条

ABSORBENT STRIP



型号 Model	名称 Name	说明 Description
C-078	吸尘器大水扒配件	进口双边胶条 Import Double Edge Rubber Strip
C-079	吸尘器小水扒	进口单边胶条 Import Single Edge Rubber Strip
C-079	带轮大水扒单边胶条40寸	进口单边胶条 Import Single Edge Rubber Strip

### 水箱

WATER TANK



型号 Model	说明 Description
HY-001	豪华型大水箱 Big Water Tank
HY-002	豪华型大水箱 Big Water Tank
A-008	小水箱 Small Water Tank

### 电子打泡箱

ELECTRONIC FOAM MACHINE



型号 Model	A-009
包装规格 Packing size	260x300x535mm
重量 Weight	8kg
容量 Capacity	5L
功率 Power	120W
电压 Voltage	220V50Hz
出泡量 Foaming rate	230mbar
安全系数 Safety grade	II级
颜色 Colour	● ●

### 美国阿美德格马达

AMETEK MOTOR



A-043

A-050

A-051

型号 Model	说明 Description	功率 Power	包装规格 Packing
A-043	抽洗机马达	1000W	6个/箱 6PCS/CTN
A-050	吸尘马达	1000W	6个/箱 6PCS/CTN
A-051	吸尘吸水马达	1000W	6个/箱 6PCS/CTN

### 中美合资马达

ITALY MOTOR



A-045

A-049(A型)

A-049(B型)

型号 Model	说明 Description	功率 Power	包装规格 Packing
A-045	吸尘马达	1000/1200W	6个/箱 6PCS/CTN
A-049(A型)	吸尘吸水马达	1000/1200/1400/1600W	6个/箱 6PCS/CTN
A-049(B型)	吸尘马达/吸尘吸水马达	1000/1200/1400/1600W	6个/箱 6PCS/CTN

### 卡扣

BUCKLE



A-068A

A-068B

A-068D

型号 Model	说明 Description
A-068A	175卡扣 175buckle
A-068B	154卡扣 154buckle
A-068D	抛光盘扣 byrnisher plate buckle



塑料制品  
PLASTIC

# MULTI-PURPOSE DUSTBIN

## 塑料制品



### 塑料制品明星产品 PLASTIC PRODUCTS STAR PRODUCT

#### 圆形储物桶 STRONG ROUND STORAGE TANK

- 全塑料结构，不会生锈、剥落、起皮;防止凹陷
- 坚固的盖子易于叠放(盖子需单独购买)
- 增强桶边，使产品更加坚实耐用
- 内置式防滑把手可逐一堆叠而节省地方，不粘黏，易取放
- 双棱纹的底座可增加稳定性和承载容量
- 有黑与黄、灰等颜色

- Full plastic, no corrosion, no flaking, no peeling, no sunken
- Strong lid is liable to stack (lid need to be purchased additionally)
- Strengthened edge, to make dustbin more durable
- Built-in type antiskid handles can be stacked to save space, nostick, easy pick and place
- Double ridges base to enhance stability and load bearing
- Black, yellow and grey color available

比原本省力  
**50%**  
over 50% easier





## 工具组合架 STRONG TOOLS COMBINED SHELF

- B-009 可选配围袋及底座
- 内置塑料袋套, 方便存放塑料袋
- 符合人体工学设计的把手容易操控, 减少接触垃圾
- 可放置瓶子、地板未干告示牌、海绵、大厅除尘畚箕、刷子、内桶卷及手套等的位置
- 由坚固耐用的塑料制成, 平滑的表面易于清洗

\*工具及清洁用品需另外购买

- With plastic bag covers inside, easy for plastic bags storage
- Handle accord with human engineering, easy operation, reducing touching with garbage
- Can place bottles, caution boards, sponge, dustpan, brush, inner barrel roll and gloves
- Made from durable plastic, smooth surface is easy to clean

\*Tools and cleaning supplies need to be purchased additionally



**B-021**  
通用加强五轮底座



**B-023**  
通用加强四轮底座



**B-022**  
工具袋



悬挂喷雾瓶、安全标识和其它各种清洁用具  
Holds spray bottles, safety signs, and many other cleaning supplies.



工具袋安装在带有轮子的桶上, 方便移动, 提高了工作的灵活性  
The tool bag is installed on a bucket with wheels, which is convenient for moving and improves the flexibility of work.



集成式工具袋更具成本效益  
Integrated tool bag is more cost-effective.

型号 Model	说明 Description	适配 Adapt to
B-021	通用加强五轮底座	B-102 / B-101
B-023	通用加强四轮底座	B-010 / B-009
B-022	工具袋	/

**B-011**

**圆形储物桶**

ROUND STORAGE BUCKET



产品规格 Measurement 34.9x40x39.8cm

容量 Capacity 23L

颜色 Color ● 黑色 black ● 红色 red ● 黄色 yellow ● 绿色 green ● 蓝色 blue



**B-011**  
(不带轮)



**B-011**  
(带轮)

新品上市  
NEWS

**B-011-3**

**圆形储物桶**

ROUND STORAGE BUCKET

产品规格 Measurement 50.3x56.4x59cm

容量 Capacity 80L

颜色 Color ● 黑色 black ● 红色 red ● 黄色 yellow ● 绿色 green ● 蓝色 blue



**B-011-3**  
(不带底座)



**B-011-3**  
(带底座)

新品上市  
NEWS

**B-011-1**

**圆形储物桶**

ROUND STORAGE BUCKET

产品规格 Measurement 40.5x45.7x44.9cm

容量 Capacity 40L

颜色 Color ● 黑色 black ● 红色 red ● 黄色 yellow ● 绿色 green ● 蓝色 blue



**B-011-1**  
(不带轮)



**B-011-1**  
(带轮)

新品上市  
NEWS

**B-011-4**

**圆形储物桶**

ROUND STORAGE BUCKET

产品规格 Measurement 57.1x64.6x71.1cm

容量 Capacity 121L

颜色 Color ● 黑色 black ● 红色 red ● 黄色 yellow ● 绿色 green ● 蓝色 blue



**B-011-4**  
(不带底座)



**B-011-4**  
(带底座)

新品上市  
NEWS

**B-011-2**

**圆形储物桶**

ROUND STORAGE BUCKET

产品规格 Measurement 48x54x55.5cm

容量 Capacity 60L

颜色 Color ● 黑色 black ● 红色 red ● 黄色 yellow ● 绿色 green ● 蓝色 blue



**B-011-2**  
(不带底座)



**B-011-2**  
(带底座)

新品上市  
NEWS

**B-011-5**

**圆形储物桶**

ROUND STORAGE BUCKET

产品规格 Measurement 61.4x69.3x81.7cm

容量 Capacity 168L

颜色 Color ● 黑色 black ● 红色 red ● 黄色 yellow ● 绿色 green ● 蓝色 blue



**B-011-5**  
(不带底座)



**B-011-5**  
(带底座)

新品上市  
NEWS

**B-011-6** 圆形储物桶  
ROUND STORAGE BUCKET

产品规格 Measurement 68.4x75.7x85.4cm

容量 Capacity 208L

颜色 Color ● 黑色 black ● 红色 red ● 黄色 yellow ● 绿色 green ● 蓝色 blue



**B-011-6**  
(不带底座)

**B-011-6**  
(带底座)



**B-006** 圆型储物桶  
CIRCULAR DUSTBIN

产品规格 Measurement 34x37cm

包装规格 Carton dimension 35.5x35.5x62.5cm

容量 Capacity 20L

包装数量 Package 5个/箱 (5pcs/CTN)

颜色 Color ● 灰色 grey



**B-006**  
可选不带盖

**B-010** 圆形储物桶(不带底座)  
**B-009** ROUND STORAGE BUCKET (WITHOUT BASE)



产品规格 Measurement B-010 40x43cm  
B-009 50x58cm

包装规格 Carton dimension B-010 42x41.7x90.7cm  
B-009 52x52x91cm

容量 Capacity B-010 40L  
B-009 80L

包装数量 Package B-010 5个/箱 (5pcs/CTN)  
B-009 5个/箱 (5pcs/CTN)

颜色 Color ● 黑色 black



**B-010**



**B-009**

**B-007** 半圆头储物桶  
HALF-ROUND HEAD DUSTBIN

产品规格 Measurement 56x97cm

容量 Capacity 120L

包装数量 Package 5个/箱 (5pcs/CTN)

颜色 Color ● 黑色 black



**B-007**

**B-009** 圆形储物桶  
**B-102** ROUND STORAGE BUCKET  
**B-101**

产品规格 Measurement B-009 50x58cm  
B-102 56x82cm  
B-101 61x93cm

容量 Capacity B-009 80L  
B-102 120L  
B-101 168L

包装数量 Package 5个/箱 (5pcs/CTN)

颜色 Color ● 黑色 black



**B-009**  
带加强四轮底座

**B-102**  
带加强五轮底座

**B-101**  
带加强五轮底座

**B-008** 漏斗型储物桶  
FUNNEL DUSTBIN

产品规格 Measurement 56x80cm

容量 Capacity 120L

包装数量 Package 5个/箱 (5pcs/CTN)

颜色 Color ● 黑色 black



**B-008**

# PEDAL DUSTBIN

## 脚踏垃圾桶



### 避免用手触碰的卫生垃圾处理而设计 DESIGN FOR NO TOUCHING BY HANDS

- 配合紧密之桶盖可防臭味溢出
- 坚固的防撞全塑料结构，不易凹陷破损
- 防噪音设计，重型脚踏板避免了用手操作，是理想的卫生用具

- Tight-fitting, overlapping lid helps contain odors
- Tough, puncture-resistant, all-plastic construction won't rust or chip
- Quiet, heavy-duty pedal for hands-free sanitary use



**B-110B  
B-110A** **手推式倾斜斗车**  
HAND PUSH TYPE TILT CONTAINER

产品规格 Measurement  
B-110B 138x60x90cm  
B-110A 145x75x105cm

容量 Capacity  
B-110B 350L  
B-110A 450L

颜色 Color  
● 蓝色 blue



B-110B

B-110A

**B-002  
B-003  
B-004** **分类垃圾桶**  
CLASSIFIED TRASH CANS

产品规格 Measurement  
B-002 48x55x80cm  
B-003 48x55x93cm  
B-004 57.5x72x104cm

容量 Capacity  
B-002 100L  
B-003 120L  
B-004 240L

包装数量 Package  
4个/箱 (4pcs/CTN)

颜色 Color  
● 灰色 gary ● 绿色 green ● 蓝色 blue ● 红色 red



B-002/B-003/B-004

**B-109** **户外垃圾车**  
OUTDOOR GARBAGE CART

产品规格 Measurement  
126x76x123cm

容量 Capacity  
660L

颜色 Color  
● 绿色 green ● 蓝色 blue ● 红色 red ● 灰色 gary



B-109

**B-002A  
B-003A  
B-004A** **脚踏式侧轮垃圾桶**  
FOOT-PEDAL SIDE-WHEEL GARBAGE BIN

产品规格 Measurement  
B-002A 48x55x80cm  
B-003A 48x55x93cm  
B-004A 57.5x72x104cm

容量 Capacity  
B-002A 100L  
B-003A 120L  
B-004A 240L

包装数量 Package  
4个/箱 (4pcs/CTN)

颜色 Color  
● 灰色 gary ● 绿色 green ● 蓝色 blue ● 红色 red



B-002A/B-003A/B-004A

**B-405** **分类垃圾桶加强款**  
HEAVY-DUTY CLASSIFIED TRASH CAN

**可挂车**

UGRADED VERSION CAN LIFTED BY GARBAGE TRUCK

产品规格 Measurement  
58.4x73.2x108.8cm

容量 Capacity  
240L

颜色 Color  
● 灰色 gary ● 绿色 green ● 蓝色 blue ● 红色 red



B-405

**B-400  
B-401  
B-403**

**环卫专用脚踏分类垃圾桶**  
EXCLUSIVE CLASSIFICATION DUSTBIN FOR SANITATION

可挂车

UGRADED VERSION CAN LIFTED BY GARBAGE TRUCK

**产品规格**  
Measurement  
B-400 56x47x77.5cm  
B-401 48.2x57x95cm  
B-403 58.4x73.2x108.8cm

**容量**  
Capacity  
B-400 100L  
B-401 120L  
B-403 240L

**包装数量**  
Package  
4个/箱 (4pcs/CTN)

**颜色**  
Color  
●灰色 ●绿色 ●蓝色 ●红色  
gary green blue red



**B-400/B-401/B-403**

**B-001A**

**脚踏式垃圾桶**  
FOUR-PEDAL GARBAGE BIN

**产品规格**  
Measurement  
41x48x68cm

**包装规格**  
Carton dimension  
44x52x103cm

**容量**  
Capacity  
60L

**包装数量**  
Package  
5个/箱 (5pcs/CTN)

**颜色**  
Color  
●灰色 ●绿色 ●蓝色  
gary green blue



**B-001A**

**B-402  
B-404**

**环卫专用脚踏分类垃圾桶**  
EXCLUSIVE CLASSIFICATION DUSTBIN FOR SANITATION

可挂车

UGRADED VERSION CAN LIFTED BY GARBAGE TRUCK

**产品规格**  
Measurement  
B-402 47.6x55.5x95.7cm  
B-404 58.4x73.2x108.8cm

**容量**  
Capacity  
B-402 120L  
B-404 240L

**包装数量**  
Package  
4个/箱 (4pcs/CTN)

**颜色**  
Color  
●灰色 ●绿色 ●蓝色 ●红色  
gary green blue red



**B-402/B-404**

**B-011C-1  
B-011B-1  
B-011A-1**

**侧轮式垃圾桶**  
SIDE-WHEEL GARBAGE BIN

**产品规格**  
Measurement  
B-011C-1 46x44x67cm  
B-011B-1 58x58x86cm  
B-011A-1 62x62x102cm

**容量**  
Capacity  
B-011C-1 60L  
B-011B-1 120L  
B-011A-1 240L

**包装数量**  
Package  
B-011C-1 5个/箱 (5pcs/CTN)  
B-011B-1 4个/箱 (4pcs/CTN)  
B-011A-1 4个/箱 (4pcs/CTN)

**颜色**  
Color  
●灰色  
gary



**B-011C-1**

**B-011B-1**

**B-011A-1**

**B-001**

**四轮移动垃圾桶**  
FOUR-WHEEL GARBAGE BIN

**产品规格**  
Measurement  
41x48x68cm

**包装规格**  
Carton dimension  
44x52x103cm

**容量**  
Capacity  
60L

**包装数量**  
Package  
5个/箱 (5pcs/CTN)

**颜色**  
Color  
●灰色 ●绿色 ●蓝色 ●红色  
gary green blue red



**B-001**

**B-011C-2  
B-011B-2  
B-011A-2**

**脚踏侧轮式垃圾桶**  
PEDAL SIDE-WHEEL GARBAGE BIN

**产品规格**  
Measurement  
B-011C-2 46x44x67cm  
B-011B-2 58x58x86cm  
B-011A-2 62x62x102cm

**容量**  
Capacity  
B-011C-2 60L  
B-011B-2 120L  
B-011A-2 240L

**包装数量**  
Package  
B-011C-2 5个/箱 (5pcs/CTN)  
B-011B-2 4个/箱 (4pcs/CTN)  
B-011A-2 4个/箱 (4pcs/CTN)

**颜色**  
Color  
●灰色  
gary



**B-011C-2**

**B-011B-2**

**B-011A-2**

**B2-010A 脚踏式分类垃圾桶**  
PEDAL CLASSIFICATION DUSTBIN

产品规格 Measurement 41.2x39.4x42.4cm  
 包装规格 Carton dimension 43x41x64.5cm  
 容量 Capacity 30L  
 包装数量 Package 3个/箱 (3pcs/CTN)  
 颜色 Color ●黄色 yellow ●黄灰色 yellow-gary ●灰色 gary ●绿色 green ●蓝色 blue ●红色 red



B2-010A

**B2-010D 脚踏式分类垃圾桶**  
PEDAL CLASSIFICATION DUSTBIN

产品规格 Measurement 48.5x42x82cm  
 包装规格 Carton dimension 49x42x105.5cm  
 容量 Capacity 87L  
 包装数量 Package 3个/箱 (3pcs/CTN)  
 颜色 Color ●黄色 yellow ●黄灰色 yellow-gary ●灰色 gary ●绿色 green ●蓝色 blue ●红色 red



B2-010D



**B2-010B 脚踏式分类垃圾桶**  
PEDAL CLASSIFICATION DUSTBIN

产品规格 Measurement 41.5x40x60cm  
 包装规格 Carton dimension 43x41x79cm  
 容量 Capacity 45L  
 包装数量 Package 3个/箱 (3pcs/CTN)  
 颜色 Color ●黄色 yellow ●黄灰色 yellow-gary ●灰色 gary ●绿色 green ●蓝色 blue ●红色 red



B2-010B

**B2-010E 脚踏式分类垃圾桶**  
PEDAL CLASSIFICATION DUSTBIN

产品规格 Measurement 40.9x39.9x43.7cm  
 容量 Capacity 30L  
 颜色 Color ●黄色 yellow ●黄灰色 yellow-gary ●灰色 gary ●绿色 green ●蓝色 blue ●红色 red



B2-010E



**B2-010C 脚踏式分类垃圾桶**  
PEDAL CLASSIFICATION DUSTBIN

产品规格 Measurement 48x43x65.5cm  
 包装规格 Carton dimension 50x43x89cm  
 容量 Capacity 68L  
 包装数量 Package 3个/箱 (3pcs/CTN)  
 颜色 Color ●黄色 yellow ●黄灰色 yellow-gary ●灰色 gary ●绿色 green ●蓝色 blue ●红色 red



B2-010C

**B2-010F 脚踏式分类垃圾桶**  
PEDAL CLASSIFICATION DUSTBIN

产品规格 Measurement 40.9x39.9x60.4cm  
 容量 Capacity 45L  
 颜色 Color ●黄色 yellow ●黄灰色 yellow-gary ●灰色 gary ●绿色 green ●蓝色 blue ●红色 red



B2-010F



**B2-010G 脚踏式分类垃圾桶**  
PEDAL CLASSIFICATION DUSTBIN

产品规格 Measurement 49.5x41.4x66.6cm

容量 Capacity 68L

颜色 Color ●黄色 yellow ●黄灰色 yellow-gary ●灰色 gary ●绿色 green ●蓝色 blue ●红色 red



**B2-010G**



**B3-010B 脚踏式分类垃圾桶**  
PEDAL CLASSIFICATION DUSTBIN

产品规格 Measurement 35x35x35cm

容量 Capacity 25L

包装数量 Package 3个/箱 (3pcs/CTN)

颜色 Color ●黄色 yellow ●黄灰色 yellow-gary ●灰色 gary ●绿色 green ●蓝色 blue ●红色 red



**B3-010B**

**B2-010H 脚踏式分类垃圾桶**  
PEDAL CLASSIFICATION DUSTBIN

产品规格 Measurement 49.5x41.4x84.2cm

容量 Capacity 87L

颜色 Color ●黄色 yellow ●黄灰色 yellow-gary ●灰色 gary ●绿色 green ●蓝色 blue ●红色 red



**B2-010H**



**B3-010C 脚踏式分类垃圾桶**  
PEDAL CLASSIFICATION DUSTBIN

产品规格 Measurement 45x35x35cm

容量 Capacity 35L

包装数量 Package 3个/箱 (3pcs/CTN)

颜色 Color ●黄色 yellow ●黄灰色 yellow-gary ●灰色 gary ●绿色 green ●蓝色 blue ●红色 red



**B3-010C**

**B3-010A 脚踏式分类垃圾桶**  
PEDAL CLASSIFICATION DUSTBIN

产品规格 Measurement 25x27.5x33cm

容量 Capacity 15L

包装数量 Package 3个/箱 (3pcs/CTN)

颜色 Color ●黄色 yellow ●黄灰色 yellow-gary ●灰色 gary ●绿色 green ●蓝色 blue ●红色 red



**B3-010A**

**B3-010D 脚踏式分类垃圾桶**  
PEDAL CLASSIFICATION DUSTBIN

产品规格 Measurement 60x35x35cm

容量 Capacity 45L

包装数量 Package 3个/箱 (3pcs/CTN)

颜色 Color ●黄色 yellow ●黄灰色 yellow-gary ●灰色 gary ●绿色 green ●蓝色 blue ●红色 red



**B3-010D**

**B3-010E 脚踏式分类垃圾桶**  
PEDAL CLASSIFICATION DUSTBIN

产品规格 Measurement 68x35x35cm  
 容量 Capacity 55L  
 包装数量 Package 3个/箱 (3pcs/CTN)  
 颜色 Color 黄色 yellow 黄灰色 yellow-gary 灰色 gary 绿色 green 蓝色 blue 红色 red



**B3-010E**

**B-015 长方形弹盖垃圾桶**  
TURNING COVER DUSTBIN

产品规格 Measurement 34x24x45cm  
 包装规格 Carton dimension 68x25x65cm  
 容量 Capacity 25L  
 包装数量 Package 10个/箱 (10pcs/CTN)  
 颜色 Color 灰色 gary 绿色 green 蓝色 blue 红色 red



**B-015**

**B-014A 四轮底座弹盖垃圾桶**  
FOUR WHEEL BASE TURNING COVER DUSTBIN

产品规格 Measurement B-014A 48x34x81cm B-014B 48x68x81cm  
 包装规格 Carton dimension B-014A 49x34x92cm B-014B 49x34x78cm  
 容量 Capacity B-014A 60L B-014B 120L  
 包装数量 Package B-014A 3个/箱 (3pcs/CTN) B-014B 1套/箱 (1pcs/CTN)  
 颜色 Color 灰色 gary 绿色 green 蓝色 blue 红色 red



**B-014A**

**B-014B**

**B-014 长方形弹盖垃圾桶**  
TURNING COVER DUSTBIN

产品规格 Measurement 39.5x28x60cm  
 包装规格 Carton dimension 54x41.5x81cm  
 容量 Capacity 42L  
 包装数量 Package 10个/箱 (10pcs/CTN)  
 颜色 Color 灰色 gary 绿色 green 蓝色 blue 红色 red



**B-014**

**B-012 房间&卫生间垃圾桶**  
ROOM&BATHROOM DUSTBIN

产品规格 Measurement 24x18x57cm  
 包装规格 Carton dimension 36.5x36.5x58cm  
 容量 Capacity 21L  
 包装数量 Package 2个/箱 (2pcs/CTN)  
 颜色 Color 蓝色 blue 灰色 gary



**B-012**

**B-013 长方形弹盖垃圾桶**  
TURNING COVER DUSTBIN

产品规格 Measurement 46x33x75cm  
 包装规格 Carton dimension 47.5x33x91cm  
 容量 Capacity 60L  
 包装数量 Package 5个/箱 (5pcs/CTN)  
 颜色 Color 灰色 gary 绿色 green 蓝色 blue 红色 red



**B-013**

**B-020 方形弹盖垃圾桶**  
TURNING COVER DUSTBIN

产品规格 Measurement 47x32x27cm

容量 Capacity 25L

颜色 Color ●灰色 gary ●绿色 green ●蓝色 blue ●红色 red



**B-020**

**B-019 方形弹盖垃圾桶**  
TURNING COVER DUSTBIN

产品规格 Measurement 60x32x40cm

容量 Capacity 40L

颜色 Color ●灰色 gary ●绿色 green ●蓝色 blue ●红色 red



**B-019**

**B-018 方形弹盖垃圾桶**  
TURNING COVER DUSTBIN

产品规格 Measurement 70x40x40cm

容量 Capacity 60L

颜色 Color ●灰色 gary ●绿色 green ●蓝色 blue ●红色 red



**B-018**

**B-017 方形弹盖垃圾桶**  
TURNING COVER DUSTBIN

产品规格 Measurement 48.5x48.5x87cm

容量 Capacity 100L

颜色 Color ●灰色 gary ●绿色 green ●蓝色 blue ●红色 red



**B-017**

**B-036 脚踏式分类垃圾桶**  
PEDAL CLASSIFICATION DUSTBIN

产品规格 Measurement 34.5x27x42cm

包装规格 Carton dimension 63x35x42cm

容量 Capacity 20L

包装数量 Package 2个/箱 (2pcs/CTN)

颜色 Color ●绿灰 green-gary ●蓝灰 blue-gray ●红灰 red-gray



**B-036**

**B-036A 脚踏式分类垃圾桶**  
PEDAL CLASSIFICATION DUSTBIN

产品规格 Measurement 43.5x34x49.5cm

容量 Capacity 40L

包装数量 Package 2个/箱 (2pcs/CTN)

颜色 Color ●绿灰 green-gary ●蓝灰 blue-gray ●红灰 red-gray



**B-036A**

**B-036D 脚踏式分类垃圾桶**  
PEDAL CLASSIFICATION DUSTBIN

产品规格 Measurement 51.5x38x61cm

容量 Capacity 60L

包装数量 Package 2个/箱 (2pcs/CTN)

颜色 Color ●绿灰 green-gary ●蓝灰 blue-gray ●红灰 red-gray



**B-036D**

**B2-017A** 分类垃圾桶  
JOINT DUSTBIN

产品规格 Measurement 30.2x54.4x88.1 cm  
容量 Capacity 87L  
颜色 Color ● 灰色 gray



B2-017A



**B2-017** 分类垃圾桶(不带底座)  
JOINT DUSTBIN

产品规格 Measurement 48x34x68cm  
包装规格 Carton dimension 49x35x85cm  
容量 Capacity 60L  
包装数量 Package 3个/箱 (3pcs/CTN)  
颜色 Color ● 蓝色 blue ● 红色 red ● 黄色 yellow



B2-017



**B2-018A** 连体分类垃圾桶  
JOINT DUSTBIN

产品规格 Measurement 30.2x54.4x88.1 cm  
容量 Capacity 87L  
颜色 Color ● 红灰 red-gray ● 黄灰 yellow-gray



B2-018A



**B2-018** 连体分类垃圾桶  
JOINT DUSTBIN

产品规格 Measurement 48x68x73cm  
包装规格 Carton dimension 49x35x85cm  
容量 Capacity 120L  
包装数量 Package 3个/箱 (3pcs/CTN)  
颜色 Color ● 蓝色 blue ● 红色 red ● 黄色 yellow



B2-018



**B2-019A** 连体分类垃圾桶  
JOINT DUSTBIN

产品规格 Measurement 30.2x54.4x88.1 cm  
容量 Capacity 87L  
颜色 Color ● 红灰 red-gray ● 黄灰 yellow-gray ● 绿灰 green-gray



B2-019A



**B2-019** 分类垃圾桶(不带底座)  
JOINT DUSTBIN

产品规格 Measurement 48x68x68cm  
包装规格 Carton dimension 49x35x85cm  
容量 Capacity 180L  
包装数量 Package 3个/箱 (3pcs/CTN)  
颜色 Color ● 蓝色 blue ● 红色 red ● 黄色 yellow



B2-019



**B2-020** 连体分类垃圾桶  
JOINT DUSTBIN

产品规格 Measurement 99x47x73cm  
包装规格 Carton dimension 49x35x85cm  
容量 Capacity 180L  
包装数量 Package 3个/箱 (3pcs/CTN)  
颜色 Color ● 蓝色 blue ● 红色 red ● 黄色 yellow



B2-020



**B-036B  
B-036B-1**

**带盖垃圾桶  
DUSTBIN**

产品规格 Measurement	B-036B 52x28x68cm B-036B-1 52x28x90cm
包装规格 Carton dimension	B-036B 60x28.5x109cm B-036B-1 50x30x105.5cm
容量 Capacity	B-036B 60L B-036B-1 80L
包装数量 Package	B-036B 5个/箱 (5pcs/CTN) B-036B-1 3个/箱 (3pcs/CTN)



**B-036B**

**B-036B-1**

**B-036C  
B-036C-1**

**免手动垃圾桶  
HAND FREE DUSTBIN**

产品规格 Measurement	B-036C 52x29x87cm B-036C-1 52x30x75cm
包装规格 Carton dimension	B-036C 53x30.5x108cm B-036C-1 63x30x92cm
容量 Capacity	B-036C 80L B-036C-1 60L
包装数量 Package	B-036C 3个/箱 (3pcs/CTN) B-036C-1 3个/箱 (3pcs/CTN)



**B-036C**

**B-036C-1**

**B-034A  
B-034C  
B-034E**

**免手动垃圾桶  
HAND FREE DUSTBIN**

产品规格 Measurement	B-034A 30.5x21.5x42.5cm B-034C 38x28x49cm B-034E 38x28x62cm
容量 Capacity	B-034A 12L B-034C 25L B-034E 35L



**B-034A**

**B-034C**

**B-034E**

**B-034B  
B-034D  
B-034F**

**方形垃圾桶  
SQUARE TRASH CAN**

产品规格 Measurement	B-034B 31X30X21cm B-034D 35X37X27cm B-034F 50X37X27cm
容量 Capacity	B-034B 12L B-034D 25L B-034F 35L



**B-034B**

**B-034D**

**B-034F**

**B-033  
B-236A  
B-235**

**圆形房间&卫生间垃圾桶  
CIRCULAR ROOM&BATHROOM DUSTBIN**

产品规格 Measurement	B-033 23.8X25.5cm (8.5L) B-236A 21X29.5cm (8.5L) B-235 21X29.5cm (8L)
包装规格 Carton dimension	B-033 50x25.2x77.5cm B-236A 52.5x40x58cm B-235 43x43x51cm
包装数量 Package	B-033 6个/箱 (6pcs/CTN) B-236A 20个/箱 (20pcs/CTN) B-235 20个/箱 (20pcs/CTN)



**B-033**

**B-236A**  
可选阻燃  
flame retardant

**B-235**

**B-035B  
B-030B**

**方形垃圾桶  
SQUARE TRASH CAN**

产品规格 Measurement	B-035B 26x17.5x26cm B-030B 23.5x16x28.5cm
包装规格 Carton dimension	B-035B 54x36x57cm B-030B 48x33.6x70cm
容量 Capacity	B-035B 8L B-030B 8L
包装数量 Package	40个/箱 (40pcs/CTN)
颜色 Color	●灰色 ●黄色 grey yellow



**B-035B**

**B-030B**  
可选阻燃  
flame retardant

**B-106**

**塑料烟灰垃圾桶  
PLASTIC ASHTRAY DUSTBIN**

产品规格 Measurement	27x58cm
包装规格 Carton dimension	58x30x60cm
容量 Capacity	20L
包装数量 Package	2个/箱 (2pcs/CTN)



**B-106**

**D-213**  
**D-214** **小水桶**  
LITTLE BUCKETS

产品规格 Measurement  
D-213 30x18x21cm  
D-214 28.5x17.5x14.5cm

容量 Capacity  
D-213 8L  
D-214 4L

颜色 Color  
D-213 ●蓝色 blue  
D-214 ●黄色 yellow



D-213



D-214

**D-225** **4升小方桶**  
4 LITRE SQUARE BARREK

产品规格 Measurement  
18.5x16x28cm

包装规格 Carton dimension  
38x40x62.5cm

包装数量 Package  
40个(单色)/箱 (40pcs/CTN)

颜色 Color  
●红色 red ●绿色 green ●蓝色 blue ●黄色 yellow



D-225



**D-207**  
**D-208** **清洁方桶**  
CLEAN BUCKET

产品规格 Measurement  
D-207 35.5x21x20cm  
D-208 45x35x26cm



D-207



D-208

**D-206** **6升小方桶**  
6 LITRE SQUARE BARREK

产品规格 Measurement  
25x22x27cm

包装规格 Carton dimension  
26x22x43.5cm

包装数量 Package  
40个(单色)/箱 (40pcs/CTN)

颜色 Color  
●红色 red ●绿色 green ●蓝色 blue ●黄色 yellow



D-206

**B-042** **打蜡桶**  
WAXING BUCKET

产品规格 Measurement  
52x26.5x33cm

包装规格 Carton dimension  
59x29x29cm

包装数量 Package  
1个/箱 (1pcs/CTN)



B-042

**D-216**  
**D-215** **18升小水桶**  
18 LITRE BUCKET

产品规格 Measurement  
D-216 29x30x28cm  
D-215 29x30x28cm

容量 Capacity  
D-216 18L  
D-215 18L

颜色 Color  
D-216 ●蓝色 blue  
D-215 ●红色 red



D-216



D-215

**D-220** **方形拖把桶**  
SQUARE MOP BUCKET

产品规格 Measurement  
52x23x20cm

包装规格 Carton dimension  
55x48x74cm

包装数量 Package  
40个/箱 (40pcs/CTN)

颜色 Color  
●蓝色 blue ●黄色 yellow ●绿色 green



D-220

**D-212**  
**D-211** **25升小水桶**  
25 LITRE BUCKET

产品规格 Measurement  
D-212 28x27x33cm  
D-211 28x27x33cm

容量 Capacity  
D-212 25L  
D-211 25L

颜色 Color  
D-212 ●蓝色 blue  
D-211 ●红色 red



D-212



D-211

**B-039B 多隔桶**  
MULTI GRID BUCKETS

产品规格 Measurement 29x25x14.8cm  
包装规格 Carton dimension 47x30x55cm  
容量 Capacity 6.5L  
包装数量 Package 20个/箱 (20pcs/CTN)



B-039B



**D-209 D-210 餐碟收集盘**  
DISHES COLLECTION PLATE

产品规格 Measurement B-209 54x38x15cm  
B-210 71x50x15cm  
包装规格 Carton dimension B-209 55x39x69cm  
B-210 72.5x51x57.5cm  
包装数量 Package B-209 20个/箱 (20pcs/CTN)  
B-210 10个/箱 (10pcs/CTN)



D-209

D-210

**B-039 B-039C 手提工具蓝**  
HAND-HELD TOOL BUCKET

产品规格 Measurement B-039 39x28x19.2cm  
B-039C 38.7x27.5x18cm  
包装规格 Carton dimension B-039 57x41x58.5cm  
B-039C 56x40x53.5cm  
包装数量 Package B-039 20个/箱 (20pcs/CTN)  
B-039C 20个/箱 (20pcs/CTN)



B-039

B-039C

**B-110 B-110-1 BB餐椅**  
YOUTH SEATS

产品规格 Measurement 63.5x58.3x76.8cm  
包装规格 Carton dimension 66x59.5x27cm  
包装数量 Package 1个/箱 (1pcs/CTN)  
重量 Weight B-110 8.2KG  
B-110-1 5.8KG



B-110

B-110-1

欧美标准

安全结实, 全新料聚丙烯对宝宝无危害

**B-041 双隔桶**  
TWIN BUCKET

产品规格 Measurement 46x35.5x26cm  
容量 Capacity 22L



B-041

**B-099D 可移动脚踏**  
MOVABLE PEDAL

产品规格 Measurement 40.7x33cm  
包装规格 Carton dimension 42x42x64.5cm



B-099D

欧美标准

安全结实, 全新料聚丙烯对宝宝无危害

**B-039D 大工具蓝**  
BIG TOOL BUCKET

产品规格 Measurement 54x39x29cm  
包装规格 Carton dimension 55x40x39.5cm  
包装数量 Package 3个/箱 (3pcs/CTN)



B-039D

方便层叠 易于存放

EASY TO STACK AND STORE

**B-099C 脚踏梯**  
FOOT LADDER

产品规格 Measurement 63.5x58.3x76.8cm  
包装规格 Carton dimension 66x59.5x27cm  
包装数量 Package 2个/箱 (2pcs/CTN)

颜色 Color 灰色 gary 绿色 green 蓝色 blue 红色 red



B-099C

欧美标准

安全结实, 全新料聚丙烯对宝宝无危害

**B-100A** 加水桶  
ADDING WATER TANK

产品规格 Measurement 30x30x26cm  
 包装规格 Carton dimension 55.5x29.5x68.5cm  
 容量 Capacity 10L  
 包装数量 Package 20个/箱 (20pcs/CTN)  
 颜色 Color ●灰色 gary ●绿色 green ●蓝色 blue ●红色 red



**B-100A**

**B-100B** 加水桶  
ADDING WATER TANK

产品规格 Measurement 38x32x30cm  
 包装规格 Carton dimension 63.5x34x52cm  
 容量 Capacity 15L  
 包装数量 Package 10个/箱 (10pcs/CTN)  
 颜色 Color ●灰色 gary ●绿色 green ●蓝色 blue ●红色 red



**B-100B**

**B-100D** 加水桶  
ADDING WATER TANK

产品规格 Measurement 32.8x34.7x29cm  
 包装规格 Carton dimension 62x33x59cm  
 容量 Capacity 14L  
 包装数量 Package 10个/箱 (10pcs/CTN)  
 颜色 Color ●灰色 gary ●绿色 green ●蓝色 blue ●红色 red



**B-100D**



**榨水车**  
**MOPPING SYSTEMS**



## 拖洗清洁系统 MOPPING SYSTEMS

拖洗清洁系统，能助您提升工作效率，减低劳工成本，超宝清洁系列从26夸脱至新增的44夸脱型号供选择，助您轻易处理任何拖洗工作快。

Mopping Systems improve productivity and help reduce labor costs. Chaobao can handle any mopping job with ease, in sizes from 26 quarts to the new 44 quart system.



### 污水分隔桶 DIRTY WATER BUCKET

- 污水和清水分隔
- 保存清洁剂的清洁能力
- 减少用水及化学物品剂量
- 令地板更洁净，且不易滑倒
- 分开液体重量; 减省提起水桶力度，令倒水更容易

- Separates dirty water from clean water
- Preserves the quality and cleaning power of cleaning solution
- Reduces water and chemical usage
- Helps produce cleaner, less slippery floors
- Divides liquid weight; less lifting power needed when emptying buckets

### 操作方法 HOW IT WORKS

传统的压水器直接把污水混入水桶的清水内桶力度，令倒水更容易  
超宝的污水分隔桶内设有压水器可独立收集污水，并把污水和清水分隔开，安全卫生

Traditionally wringers release dirty water directly back into the bucket's primary cleaning water. Chaobao's Dirty Water Bucket nests below the Wringer to collect the dirty water and keep it separate from the cleaning solution.



## B-044D

### 34L下压式榨水车

DOWN-PRESS SINGLE MOP WRINGER TROLLEY

(搭配B-044C榨水头圆头手柄)

产品规格 Measurement	52.5X43X82.5cm
包装规格 Carton dimension	51.5X37.5X42cm
容量 Capacity	34L
包装数量 Package	1个/箱 (1pcs/CTN)



B-044D



## B-044D-2

### 34L侧压式双桶榨水车

DOUBLE MOP WRINGER TROLLEY

(搭配B-040C-3榨水头)

产品规格 Measurement	57.4x43x91.5cm
包装规格 Carton dimension	51.5x37.5x44.5cm
容量 Capacity	34L
包装数量 Package	1个/箱 (1pcs/CTN)



B-044D-2



## B-040C B-040C-1 B-040C-2

### 24L单桶榨水车

SINGLE MOP WRINGER TROLLEY

单桶榨水车可放置在多用途清洁手推车上  
THE SINGLE MOP TROLLEY COULD MATCH THE MULTI-PURPOSE CLEANING CART

产品规格 Measurement	B-040C	52x36x90cm
	B-040C-1	52x36x90cm
	B-040C-2	35x50x85cm
包装规格 Carton dimension	B-040C	46x37x43.5cm
	B-040C-1	46x37x43.5cm
	B-040C-2	46.5x39x36cm
容量 Capacity	B-040C	24L
	B-040C-1	24L
	B-040C-2	24L
包装数量 Package	1个/箱 (1pcs/CTN)	



B-040C

B-040C-1

B-040C-2

## B-040D B-040D-1 B-040D-2

### 32L单桶榨水车

SINGLE MOP WRINGER TROLLEY

单桶榨水车可放置在多用途清洁手推车上  
THE SINGLE MOP TROLLEY COULD MATCH THE MULTI-PURPOSE CLEANING CART

产品规格 Measurement	B-040D	54x38x90cm
	B-040D-1	54x38x90cm
	B-040D-2	56x35x90cm
包装规格 Carton dimension	B-040D	51.5x41.5x36cm
	B-040D-1	51.5x41.5x36cm
	B-040D-2	50.5x39x36.5cm
容量 Capacity	B-040D	32L
	B-040D-1	32L
	B-040D-2	32L
包装数量 Package	1个/箱 (1pcs/CTN)	



B-040D

B-040D-1

B-040D-2

## B-040 B-040-1 B-040-2

### 36L单桶榨水车

SINGLE MOP WRINGER TROLLEY

单桶榨水车可放置在多用途清洁手推车上  
THE SINGLE MOP TROLLEY COULD MATCH THE MULTI-PURPOSE CLEANING CART

产品规格 Measurement	B-040	55x39x91cm
	B-040-1	55x39x91cm
	B-040-2	55x39x91cm
包装规格 Carton dimension	B-040	51.5x41.5x36cm
	B-040-1	51.5x41.5x36cm
	B-040-2	51.5x41.5x36cm
容量 Capacity	B-040	36L
	B-040-1	36L
	B-040-2	36L
包装数量 Package	1个/箱 (1pcs/CTN)	



B-040

B-040-1

B-040-2

**B-038**  
**B-038-1**

**20L轻便式单桶榨水车**  
SINGLE MOP WRINGER TROLLEY

单桶榨水车可放置在多用途清洁手推车上  
THE SINGLE MOP TROLLEY COULD MATCH THE MULTI-PURPOSE CLEANING CART

产品规格 Measurement	B-038	40x27x34cm
	B-038-1	40x27x34cm
包装规格 Carton dimension	B-038	46.5x27x29cm
	B-038-1	46.5x27x29cm
容量 Capacity	B-038	20L
	B-038-1	20L
包装数量 Package	1个/箱 (1pcs/CTN)	



**B-038**

**B-038-1**

**B-038A**  
**B-038A-1**

**20L轻便式单桶榨水车**  
SINGLE MOP WRINGER TROLLEY

单桶榨水车可放置在多用途清洁手推车上  
THE SINGLE MOP TROLLEY COULD MATCH THE MULTI-PURPOSE CLEANING CART

产品规格 Measurement	B-038A	40x27x34cm
	B-038A-1	40x27x34cm
包装规格 Carton dimension	B-038A	48x28x28cm
	B-038A-1	48x28x28cm
容量 Capacity	B-038A	20L
	B-038A-1	20L
包装数量 Package	1个/箱 (1pcs/CTN)	



**B-038A**

**B-038A-1**

**B-040C-3**  
**B-040D-3**

**可排水单桶榨水车**  
DRAINABLE SINGLE MOP WRINGER TROLLEY

单桶榨水车可放置在多用途清洁手推车上  
THE SINGLE MOP TROLLEY COULD MATCH THE MULTI-PURPOSE CLEANING CART

产品规格 Measurement	B-040C-3	35x50x85cm
	B-040D-3	56x35x90cm
包装规格 Carton dimension	B-040C-3	46.5x39x36cm
	B-040D-3	50.5x39x36.5cm
容量 Capacity	B-040C-3	24L
	B-040D-3	32L
包装数量 Package	1个/箱 (1pcs/CTN)	



**B-040C-3(24L)**  
带尾部排水管

**B-040D-3(32L)**  
带尾部排水管



**B-044**

**18L下压式单桶榨水车**  
DOWN-PRESS SINGLE MOP WRINGER TROLLEY

单桶榨水车可放置在多用途清洁手推车上  
THE SINGLE MOP TROLLEY COULD MATCH THE MULTI-PURPOSE CLEANING CART

产品规格 Measurement	39.5x38x49cm
包装规格 Carton dimension	59x39x41cm
容量 Capacity	18L
包装数量 Package	1个/箱 (1pcs/CTN)



**B-044**

**B-045**

**36L下压式双桶榨水车**  
DOUBLE MOP WRINGER TROLLEY

产品规格 Measurement	40x27x34cm
包装规格 Carton dimension	66.5x40.5x42cm
容量 Capacity	36L
包装数量 Package	1个/箱 (1pcs/CTN)



**B-045**

**B-045B**

**36L下压式双桶榨水车**  
DOUBLE MOP WRINGER TROLLEY

产品规格 Measurement	78x27x34cm
包装规格 Carton dimension	86.5x44.5x52cm
容量 Capacity	36L
包装数量 Package	1个/箱 (1pcs/CTN)



**B-045B**

**B-044C** 25L下压式单桶榨水车  
DOWN-PRESS SINGLE MOP WRINGER TROLLEY

产品规格 Measurement 46.2x39.2x75.8cm  
包装规格 Carton dimension 43.5x33x39cm  
容量 Capacity 25L  
包装数量 Package 1个/箱 (1pcs/CTN)



**B-044C**

B-040C-2/3

B-040D-2/3

B-043

B-044C榨水头可适配多种榨水车  
B-044C WATER SQUEEZING HEAD CAN BE ADAPTED TO A VARIETY OF WATER SQUEEZING CARTS

**B-044B** 28L下压式单桶榨水车  
DOWN-PRESS SINGLE MOP WRINGER TROLLEY

产品规格 Measurement 63x42x94cm  
包装规格 Carton dimension 54x39x52.5cm  
容量 Capacity 28L  
包装数量 Package 1个/箱 (1pcs/CTN)

单桶榨水车可放置在多用途清洁手推车上  
THE SINGLE MOP TROLLEY COULD MATCH THE MULTI-PURPOSE CLEANING CART



**B-044B**

**B-043** 50L侧压式双桶榨水车  
DOUBLE MOP WRINGER TROLLEY

产品规格 Measurement 40x27x34cm  
包装规格 Carton dimension 84x42x38cm  
容量 Capacity 50L  
包装数量 Package 1个/箱 (1pcs/CTN)



**B-043**

**B-46** 下压式双桶榨水车  
DOUBLE MOP WRINGER TROLLEY

产品规格 Measurement 84x43x96cm  
包装规格 Carton dimension 80x44x52cm  
容量 Capacity 35L/15L/4L  
包装数量 Package 1个/箱 (1pcs/CTN)



**B-46**

**B-047** 50L侧压式双桶榨水车  
DOUBLE MOP WRINGER TROLLEY

产品规格 Measurement 40x27x34cm  
包装规格 Carton dimension 92x39x39cm  
容量 Capacity 50L  
包装数量 Package 1个/箱 (1pcs/CTN)



**B-047**

**B-46B** 下压式单桶榨水车  
DOWN-PRESS SINGLE MOP WRINGER TROLLEY

产品规格 Measurement 58x39x86cm  
包装规格 Carton dimension 53x39x59cm  
容量 Capacity 35L/15L  
包装数量 Package 1个/箱 (1pcs/CTN)



**B-46B**



## 告示牌 CAUTION BOARD

重量轻且用途广，对安全有举足轻重的作用  
In light weight, wide application, important for safety



**新款小号A字形告示牌**  
NEW SMALL SHAPE OF A CAUTION BOARD

**产品特点** Product Feature

- ✓ 全新优质塑料注塑成型，产品为PP料；
- ✓ 外观光洁平整精美厚实，产品不老化变形，高温暴晒及低温严寒情况下使用，一样历久如新；
- ✓ 警示图案及字样清晰，配有中英文字体，款式多种多样
- ✓ 适用于宾馆、酒店及各类公共场所使用。

The product is made of brand new ABS or PP plastic material through injection moulding; It has a sheeny and smooth surface, being strong and beautiful. The product does not get aged and deformed. Even placed in an environment of high temperature, under insolation or in vigorous winter it still keeps new after use along time; The text in Chinese and English pattern on it are clear. There are many designs of this product; It is suitable for hotels, restaurants and other public sites.

材料 Material: PP料 ABS料  
包装尺寸 Packing size: 64x31x26cm  
包装数量 Package: 10个/箱 (10pcs/CTN)



**新款中号A字形告示牌**  
NEW MEDIUM SHAPE OF A CAUTION BOARD

**产品特点** Product Feature

- ✓ 全新优质塑料注塑成型，产品为PP料；
- ✓ 外观光洁平整精美厚实，产品不老化变形，高温暴晒及低温严寒情况下使用，一样历久如新；
- ✓ 警示图案及字样清晰，配有中英文字体，款式多种多样
- ✓ 适用于宾馆、酒店及各类公共场所使用。

The product is made of brand new ABS or PP plastic material through injection moulding; It has a sheeny and smooth surface, being strong and beautiful. The product does not get aged and deformed. Even placed in an environment of high temperature, under insolation or in vigorous winter it still keeps new after use along time; The text in Chinese and English pattern on it are clear. There are many designs of this product; It is suitable for hotels, restaurants and other public sites.

材料 Material: PP料 ABS料  
包装尺寸 Packing size: 83x31.5x42cm  
包装数量 Package: 12个/箱 (12pcs/CTN)



B-131-M

B-132-M



B-131-S B-132-S B-134-S B-136-S B-137-S B-140-S



B-141-S B-144-S B-147-S B-148-S B-150-S B-152-S



B-134-M B-135-M B-136-M B-139-M B-140-M B-141-M



B-144-M B-146-M B-147-M B-148-M B-149-M B-152-M

**A字形告示牌**

THE SHAPE OF A CAUTION BOARD

**产品特点 Product Feature**

- ✓ 全新优质塑料注塑成型，产品为PP料；
- ✓ 外观光洁平整精美厚实，产品不老化变形，高温暴晒及低温严寒情况下使用，一样历久如新；
- ✓ 警示图案及字样清晰，配有中英文字体，款式多种多样
- ✓ 适用于宾馆、酒店及各类公共场所使用。

The product is made of brand new ABS or PP plastic material through injection moulding; It has a sheeny and smooth surface, being strong and beautiful. The product does not get aged and deformed. Even placed in an environment of high temperature, under insolation or in vigorous winter it still keeps new after use along time; The text in Chinese and English pattern on it are clear. There are many designs of this product; It is suitable for hotels, restaurants and other public sites.

材料 Material: PP料 ABS料  
 包装尺寸 Packing size: 63.5x31x30cm  
 包装数量 Package: 10个/箱 (10pcs/CTN)



**小号直立告示牌**

SMALL UPRIGHT CAUTION BOARD

**产品特点 Product Feature**

- ✓ 双语及图示印刷警示标语
- ✓ 四边形结构更方便叠放，节省存放空间
- ✓ 全新优质塑料注塑成型
- ✓ 外观光洁平整精美厚实，稳重大方，产品不老化变形，高温暴晒及低温严寒情况下使用，一样历久如新

Bilingual and pattern caution slogan  
 Quadrangle structure, easy folding and stack, save storage space  
 By high quality injection molding with brand new material  
 Smooth and flat surface, no aging and deformation, always new even in hot or cold environment

包装尺寸 Packing size: 63.5x31x30cm  
 包装数量 Package: 6个/箱 (6pcs/CTN)



B-144 B-131 B-132 B-136 B-141 B-139 B-138



B-133 B-134 B-137 B-142 B-143 B-146 B-147



B-136-X B-137-X B-139-X B-140-X B-141-X

B-144-X B-146-X B-147-X B-150-X B-153-X

大号直立告示牌

LARGE UPRIGHT CAUTION BOARD

产品特点 Product Feature

- ✓ 双语及图示印刷警示标语
- ✓ 四边形结构更方便叠放，节省存放空间
- ✓ 全新优质塑料注塑成型
- ✓ 外观光洁平整精美厚实，稳重大方，产品不老化变形，高温暴晒及低温严寒情况下使用，一样历久如新

Bilingual and pattern caution slogan  
 Quadrangle structure, easy folding and stack, save storage space  
 By high quality injection molding with brand new material  
 Smooth and flat surface, no aging and deformation, always new even in hot or cold environment

包装尺寸 114x32.5x32.5cm  
 Packing size

包装数量 6个/箱 (6pcs/CTN)  
 Package



B-148-Z



B-135-Z



B-150-Z



B-153-Z



B-132-Z



B-134-Z



B-140-Z



B-141-Z



B-146-Z



B-144-Z

悬挂告示牌

HANG A NOTICE BOARD

产品特点 Product Feature

- ✓ 外观光洁平整精美厚实，产品不老化变形，高温暴晒及低温严寒情况下使用，一样历久如新；
- ✓ 警示图案及字样清晰，配有中英文字体，款色多种多样；
- ✓ 适用于宾馆、酒店及各类公共场所使用。

It has a sheeny and smooth surface, being strong and beautiful. The product does not get aged and deformed. Even placed in an environment of high temperature, under insolation or in vigorous winter it still keeps new after use along time;  
 The text in Chinese and English pattern on it are clear. There are many designs of this product;  
 It is suitable for hotels, restaurants and other public sites.

产品尺寸 33x33.5x66cm  
 Product size

包装尺寸 34x28x83cm  
 Packing size

包装数量 10个/箱 (10pcs/CTN)  
 Package



B-130



新品上市  
 NEWS



# 清洁车

## CLEANING CAR SERIES

### 多用途平台式手推车

#### MULTI PURPOSE FLAT TROLLEY

多功能工作台和静音脚轮使得重型平架推车无论在公共区域还是后台工作区,都是理想的选择

Multi function working platform and sound proof wheels, heavy flat shelf trolley is best choice in public place or backstage working area.

### 载重负荷: 200KG

#### 托槽个性化的设计

托槽设计允许插入钢管或卷轴,以摆放金属线圈或其他卷形物料

#### Bracket individual design

Steel pipe or roll can be put in bracket, to place metal coils or other rolling material

#### 超大面积工作平台

齐平式顶架可摆放超大物件,更是智能化的工作平台

#### Super space working platform

Flush type top frame allow big articles, also it is intelligentized working platform



#### 静音脚轮

静音脚轮能减轻震动,保护地板,并且运行安静,在油布,瓷砖,水磨石,木材,光滑的混凝土和地毯上都运行自如

#### Sound proof wheels

Sound proof wheels will relieve shake, to protect floors, and make running quietly, which can run smoothly on oilcloth, ceramic tile, waterstone, wood, smooth concrete and carpet.

#### 操作更安全

符合人体工程学的手柄设计更易于人工控制,同时提高操作人员的安全性

#### Safe operation

Handle designed accord with human body, easy holding and safe operation

#### 嵌入式工具箱 工作更有效

嵌入式工具箱保证工具在运输途中仍摆放有序,并且能够轻易获取

#### Insert tools box, more efficient

Insert tools box ensure tools in order during transportation, and they are easy to be gotten



### 多用途平台式手推车 MULTIPURPOSE FLAT TROLLEY



D-017

型号 Model	产品尺寸 Product size	包装尺寸 Packing size	颜色 Colour	包装规格 Packing
D-017	106x49.5x93.5cm	108x49.5x24cm	●	1台/箱 1PCS/CTN

### 多用途平台式手推车 MULTIPURPOSE FLAT TROLLEY



D-018

型号 Model	产品尺寸 Product size	包装尺寸 Packing size	颜色 Colour	包装规格 Packing
D-018	114x62.5x99cm	116x63x21cm	●	1台/箱 1PCS/CTN

### 多用途平台式手推车 MULTIPURPOSE FLAT TROLLEY



型号 Model	产品尺寸 Product size	包装尺寸 Packing size	颜色 Colour	包装规格 Packing
D-12	91x60.5x97cm	92.5x62x16cm	●	1台/箱 1PCS/CTN
D-12B	80.7x52.3x91cm	83x85x67.5cm	●	1台/箱 1PCS/CTN

### 收集桶 GATHERING BIN



D-202  
小收集桶

D-201  
大收集桶

### 多用途三层手推车 LARGE MULTIPURPOSE 3 LAYERS CART

美观耐用的三层手推车，灵活耐用，适用于室内搬运工作  
Attractive and durable three shelf trolley, it is flexiblesuitable for using in indoors transportation

- 不留痕迹的旋转脚轮
- 台面宽敞，可放置各种不同的设备和用品
- 可配备可锁式门、隔板、杂物箱
- Swivel casters without trace
- The table is spacious, can be placed in various equipmentand supplies
- Can be equipped with a lockable door, partition, glove box



D-013



D-013N



D-013C



D-012



D-012N



D-012C

型号 Model	产品尺寸 Product size	包装尺寸 Packing size	颜色 Colour	包装规格 Packing
D-013	80x41x90cm	76x42.5x28.5cm	●	1台/箱 1PCS/CTN
D-012	103x51x96cm	93x51x26.5cm	●	1台/箱 1PCS/CTN
D-013N	83x40x91cm	66x44.5x23.5cm	●	1台/箱 1PCS/CTN
D-012N	102x48x98cm	88x51.5x23.5cm	●	1台/箱 1PCS/CTN
D-013C	86x47x92.5cm	77x48.5x32cm	●	1台/箱 1PCS/CTN
D-012C	104x51x96cm	95x52x32cm	●	1台/箱 1PCS/CTN

## 多用途三层手推车 LARGE MULTIPURPOSE 3 LAYERS CART

### 坚固耐用、任务功能齐全的推车

Durable and fully functional cart for tasks

- 铸模搁板不会生锈、凹陷或剥落
- 塑料结构有助于减小噪音
- 两端均有方便的把手，车身灵巧，操作更灵活
- 不留痕迹的旋转脚轮，可以减少善后处理工作
- Molded shelves won't rust, dent, or require painting
- Plastic construction is easy to clean and minimizes noise
- Convenient handles and compact size enhance maneuverability
- Non-marking swivel casters reduce touch-up cleaning

三层餐车系列可搭配D-202、D-201  
Three-tier dining car series fitting D-202/D-201



D-202  
小收集桶

D-201  
大收集桶



D-012A  
大号多用途三层手推车(带门)



D-013A  
小号多用途三层手推车(带门)



D-012B  
大号多用途三层手推车



D-013B  
小号多用途三层手推车

型号 Model	产品尺寸 Product size	包装尺寸 Packing size	颜色 Colour	包装规格 Packing
D-012A	104x51x96cm	95x52x32cm	●	1台/箱 1PCS/CTN
D-013A	86x47x92.5cm	77x48.5x32cm	●	1台/箱 1PCS/CTN
D-012B	104x51x96cm	95x52x32cm	●	1台/箱 1PCS/CTN
D-013B	86x47x92.5cm	77x48.5x32cm	●	1台/箱 1PCS/CTN

## 服务车与多用车 SERVICE CART AND UTILITY CART

### 美观实用的组合、整理和搬运物品的需要

The need for attractive and practical combinations, the need to arrange and move things

- 功能多样、结构坚固和价格经济的推车
- 铝制立柱可确保稳定性
- “分拆”后运输，以减少货运成本。
- 易于装配
- Versatile, durable and economically-priced carts
- Aluminum uprights ensure stability
- Ships "knocked down" to minimize shipping costs.
- Easy to assemble.



D-14A  
不锈钢三层餐车



D-14C  
不锈钢三层餐车



D-016-1  
餐盘收集车



D-016  
餐盘收集车



D-015  
餐盘收集车



D-015N  
餐盘收集车



D-016N  
餐盘收集车

型号 Model	产品尺寸 Product size	包装尺寸 Packing size	包装规格 Packing
D-14A	小号 75x40x83.5cm	/	1台/箱 1PCS/CTN
	中号 85x45x90cm	/	1台/箱 1PCS/CTN
	大号 95x50x90cm	/	1台/箱 1PCS/CTN
D-14C	小号 75x40x90cm	/	1台/箱 1PCS/CTN
	中号 85x45x90cm	/	1台/箱 1PCS/CTN
	大号 95x50x90cm	/	1台/箱 1PCS/CTN
D-016-1	80.5x45.5x88.5cm	85x16x82cm	2台/箱 2PCS/CTN
D-016	80x44x93cm	82x21.5x82cm	2台/箱 2PCS/CTN
D-015	106x58x99cm	106.5x65x84.5cm	2台/箱 2PCS/CTN
D-015N	102x46x90cm	103x47x32cm	1台/箱 1PCS/CTN
D-016N	82x42x82cm	82x42x36cm	1台/箱 1PCS/CTN

## 更专业的清洁

超宝商务用品开发了一整套用于专业清洁的高质量产品。我们的产品经反复测试，可靠、耐用。超宝的一整套个性化清洁产品和清洁系统使工作效率最大化——帮助您节约时间和金钱。

### SMARTER CLEANING

Chaobao developed a complete set of professional cleaning supplies. The products went through repeated test, they are reliable and durable. Chaobao's complete set of cleaning supplies and cleaning system make maximum work efficiency-to save time and money.

## 改善工作效率

改良性的设计，通过减少喷溅、隔离污水和清水、减少清水和化学物质的使用，实现更快速、安全的清洁。

### IMPROVE PRODUCTIVITY

Revolutionary design makes cleaning faster and safer by reducing splashing, separating dirty water from clean water, and reducing water and chemical usage.



# 全套解决方案 COMPLETE SYSTEM SOLUTIONS



#### 可将拖把及扫把储存在夹中

极具创意的软胶工具夹子，可固定手柄的任何位置(手柄直径可达11/8英寸)

#### Secure mop and broom storage

Innovative rubber Tool Grips hold handles at any position, up to 11/8" in diameter.



#### 垃圾桶盖及储存盒

设有可存放笔记本、笔和的个人物品的实用型工具箱

#### Waste Cover & storage compartment

Helps meet Joint Commission standards for waste coverage and offers functional storage for personal items.



#### 静音脚轮组件

静音脚轮组件是您顺畅安静操作的有力保障

#### Quiet Casters & Wheels

Red Quiet Casters and wheel treads are your assurance of smooth, quiet operation.



## 多用途清洁手推车 MULTIPURPOSE CLEANING CART

最完善、最有效的酒店设施清洁方案  
Complete and effective hotel cleaning solution

- 双向开合式车门(置于车身两边)
- 标准带锁储存柜, 安全带锁顶罩, 垃圾桶盖
- 备有可连接微纤桶及防溢拖把桶的锁入式连接扣
- 静音设计的方向轮及固定轮
- 防滑手柄, 手感舒适
- 可配超宝垃圾桶
- 铸有4个安全指示牌挂钩
- Bidirectional Retractable Door(on two sides of trolley)
- Standard cabinet with lock, safety cover with lock, dustbin lid
- Sound proof orientation wheel and fixing wheel
- Skid resistant handle, comfortable hands feel
- Can storage dustpan/dust cleaner for lobby
- ChaoBao dustbin is available
- With 4 caution boards hooks



D-011-2C  
多用途清洁手推车



D-011-3C  
多用途带盖清洁手推车  
(带双桶榨水头)



D-011-2  
多用途清洁三层手推车



配件



D-011-3  
多用途带盖清洁三层手推车  
(带双桶榨水头)

配件

### 参数 Specification

型号 Model	D-011-2C	D-011-2	D-011-3C	D-011-3
产品尺寸 Product size	142x60.3x112.6cm	142x60.3x133.6cm	142x60.3x112.6cm	142x60.3x133.6cm
包装尺寸 Packing size	100x60x55cm	100x60x55cm	102x62x58cm	102x62x58cm
净重 Net weight	32.5kg	35.5kg	38kg	41kg
毛重 Gross weight	37kg	40kg	42.5kg	45.5kg
包装规格 Packing	/	1台/箱	/	1台/箱

## 多用途清洁手推车 MULTIPURPOSE CLEANING CART

三倍容量可循环清洁推车助您提升工作效率, 减低劳工成本, 同时可以将各种清洁物品快捷有效地分类。您更可选择特别订造型号的推车, 配合循环再用及绿色清洁运动

- 每个拉链袋的容量高达34加仑, 有红、绿、蓝三色供选, 并印有循环使用标志, 而黄色环保袋可用作处理一般废物(拉链袋须另外购买)
- 塑料工具夹件可垂直手柄
- 用不生锈、易清洁的铝料及坚固的塑料制造
- 4"旋转小脚轮及8"大轮子

Maximize productivity and help reduce labor costs with the Triple Capacity Cart. High capacity cart provides multi-stream collection for efficient, cost-effective sortation. Customizable options support recycling and green cleaning.

- High capacity zippered bags hold up to 34 gallons each (total of 12 bushels); available in Red, Green, and Blue with universal recycling symbol and Yellow for general waste (bags sold separately)
- Rubber Tool Grips hold handles upright
- Non-rusting and easy-to-clean aluminum and structural web plastic construction
- Features 4" swivel casters and 8" wheels



多功能储存组合系统  
有效整理并储存工具, 配合可移除胶桶及其他配件(另外购买)  
VERSATILE STORAGE OPTIONS  
Organize and store supplies and tools with removable caddies and other accessories (sold separately).



D-011-2D  
多用途清洁手推车



D-011-2B  
多用途清洁手推车



配件

### 吸尘器及扫把储存系统

具有两个把手包括塑料工具夹子可固定直径1吋的手柄, 包括商用直立式吸尘器  
SECURE VACUUM & BROOM STORAGE  
Both handles include rubber Tool Grips that hold handles up to 1 1/8" in diameter, including commercial upright vacuums

### 舒适的推车手柄

改良后的设计令推车时变得更容易控制  
COMFORT GRIP CART HANDLE  
Improved design makes the cart more maneuverable and comfortable

### 大容量乙烯基环保袋

内层用聚氯乙烯(PVC)制造的防漏乙烯基环保袋, 容量高达34加仑, 令清理废物变得更有效率, 前开式的拉链设计令抛弃废物时更简单容易(环保袋须另外购买)  
HIGH CAPACITY VINYL BAG  
PVC lined, leak-proof vinyl bags hold up to 34 gallons, improving productivity by reducing the number of trips to empty waste. Zippered front access makes waste removal easier. (Bags sold separately.)

### 嵌入式储存空间

在中央收集袋的下方设有大容量的储存空间  
RECESSED STORAGE AREA  
Large, open storage area below center bag.



D-011-2D  
多用途清洁手推车

### 参数 Specification

型号 Model	D-011-2D	D-011-2D	D-011-2B
包装尺寸 Packing size	102x33x60cm	102x33x60cm	80x21x83.5cm
包装规格 Packing	1台/箱	1台/箱	1台/箱



## 医洁分类清洁手推车 MEDICAL CLEANING CART

### 医疗系统专属定制

四色小桶分类清晰、静音不扰，灵活大容量一站式满足储存整理需求

Medical system exclusive customization, four-color small bucket classification is clear, silent and not disturbing, flexible large capacity to meet the storage and organization needs in one.

- 新款静音脚轮，安静操作不留痕迹
- 多用工具夹子，存放多种清洁工具
- 功能齐全，内置各种清洁工具固定位，满足各种日常清洁需要
- The new silent wheels quiet operation leave no trace
- Multi functional tool clamp store various cleaning tools
- Complete function, built-in various cleaning tools fixed position, to meet the needs of daily



可适配超宝6L小方桶



D-11D  
医洁分类带盖清洁手推车



D-11B  
医洁分类带盖清洁手推车



D-11D  
医洁分类清洁三层手推车  
(带双桶榨水头)



D-11A  
医洁分类带盖清洁三层手推车

### 参数 Specification

型号 Model	D-11D	D-11B	d-11D(带双桶榨水头)	D-011A
产品尺寸 Product size	128x80x100cm	134.5x79x97.8cm	128.2x79x97.8cm	128x80x115cm
包装尺寸 Packing size	85x56x40cm	86x56x34cm	86x56x40cm	85x56x40cm(手推车) 55x40x39.5cm(工具篮) 26x22x43.5cm(方桶)
包装规格 Packing	1台/箱	1台/箱	1台/箱	1台/3箱

## 多用途清洁手推车 MULTIPURPOSE CLEANING CART

### 经济实用的储物搬运工具

Economical and practical storage and transportation tool

- 新款静音脚轮，安静操作不留痕迹
- 多用工具夹子，存放多种清洁工具
- 多种组合，适用于多个使用场景
- The new silent wheels quiet operation leave no trace
- Multi functional Tool clamp store various cleaning tools
- Multiple combinations, suitable for multiple usage scenarios



D-10系列清洁车可适配超宝4L小方桶



D-10A  
多用途清洁手推车

D-10B  
多用途带盖清洁手推车

#### 参数 Specification

型号 Model	D-10A	D-10B
产品尺寸 Product size	113x45x95cm	113x45x95cm
包装尺寸 Packing size	90x26.7x53.3cm	90x26.7x53.3cm
颜色 Color	●	●
包装规格 Packing	1台/箱	1台/箱

## 多用途清洁手推车 MULTIPURPOSE CLEANING CART



D-10C  
多用途清洁手推车

D-10D  
多用途带盖清洁手推车

#### 参数 Specification

型号 Model	D-10C	D-10D
产品尺寸 Product size	113x45x95cm	113x45x95cm
包装尺寸 Packing size	90x26.7x53.3cm	90x26.7x53.3cm
颜色 Color	●	●
包装规格 Packing	1台/箱	1台/箱

## 多用途带盖清洁手推车 MULTIPURPOSE CLEANING CART WITH COVER



D-10E  
多用途带盖清洁手推车

#### 参数 Specification

型号 Model	D-10E
产品尺寸 Product size	113x45x95cm
包装尺寸 Packing size	90x26.7x53.3cm
颜色 Color	●
包装规格 Packing	1台/箱

## 多用途带盖清洁手推车 MULTIPURPOSE CLEANING CART WITH COVER



D-10F  
多用途带盖清洁手推车

#### 参数 Specification

型号 Model	D-10F
产品尺寸 Product size	113x45x95cm
包装尺寸 Packing size	90x26.7x53.3cm
颜色 Color	●
包装规格 Packing	1台/箱

## 加厚型多用途清洁手推车 MULTIPURPOSE CLEANING CART

加厚耐用不挑场景，经济实用的储物搬运必备工具  
Thickened and durable, suitable for any scene,  
a must-have tool for economical storage and transportation.

- 新款静音脚轮，安静操作不留痕迹
- 多用工具夹子，存放多种清洁工具；
- The new silent wheels quiet operation leave no trace
- Multi functional Tool clamp store various cleaning tools



D-11系列清洁车可适配超宝4L小方桶

D-11

### 参数 Specification

型号 Model	D-11
产品尺寸 Product size	114x51x98cm
包装尺寸 Packing size	88x26.5x55cm
颜色 Color	● ● ●
包装规格 Packing	1台/箱

## 加厚型多用途带盖清洁手推车 MULTIPURPOSE CLEANING CART WITH COVER



D-11-1

### 参数 Specification

型号 Model	D-11-1
产品尺寸 Product size	114x51x98cm
包装尺寸 Packing size	88x26.5x55cm
颜色 Color	● ● ●
包装规格 Packing	1台/箱

## 加厚型多用途带盖清洁手推车 MULTIPURPOSE CLEANING CART WITH COVER



D-11-1C

### 参数 Specification

型号 Model	D-11-1C
产品尺寸 Product size	114x51x98cm
包装尺寸 Packing size	124x30x51cm
颜色 Color	● ● ●
包装规格 Packing	1台/箱

## 重装型多用途带盖清洁手推车 MULTIPURPOSE CLEANING CART WITH COVER



D-11C-1  
(带双桶榨水头)

D-11C

### 参数 Specification

型号 Model	D-11C-1	D-11C
产品尺寸 Product size	114x51x98cm	114x51x98cm
包装尺寸 Packing size	128x30x54cm	92x29x57cm
颜色 Color	●	●
包装规格 Packing	1台/箱	1台/箱



## 标准型客房服务车

### GUEST ROOM SERVICE TROLLEY

用途广泛，功能齐全，其大小能满足各种环境的需要

- 商业级的铸模成形结构，具有容易清洗的表面和铸模成形的色彩
- 脚轮不会在地板上留下痕迹
- 标准设备包括塑料袋、防撞装置、吸尘器存放架及车底搁板
- 大容量柜子提供特别宽敞的储存空间以及可调整的中层搁板
- 依据人体学设计的圆形手柄抓握容易、方便操控

Various purposes, multifunctional, the size meets a environments requirement

- Commercial casting for ming structure, with easy cleaning surface and casting color
- No trace on floor from wheels
- Standard accessories include plastic bag, collision-prevention device, cleaner putting shelf and bottom shelf
- Large capacity cabinet provide capacious storage space, middle shelf is adjustable
- Round handle designed accord with human body, easy holding, convenient operation

## 客房服务车

### GUEST ROOM SERVICE CART



D-205N

#### 参数 Specification

型号 Model	D-205N
产品尺寸 Product size	152.4x55.9x125cm
包装尺寸 Packing size	154x57x37cm
包装规格 Packing	1台/箱

## 客房服务车

### GUEST ROOM SERVICE CART



工具格 Tool grid



D-205A



D-205

#### 参数 Specification

型号 Model	D-205A	D-205
产品尺寸 Product size	152.4x55.9x127cm	152.4x55.9x127cm
包装尺寸 Packing size	155x58x48cm	155x58x48cm
包装规格 Packing	1台/箱	1台/箱

全金属喷塑房口车

GUEST ROOM SERVICE CART



D-203  
(带盖)



D-203A  
(无盖)

参数 Specification

型号 Model	D-203	D-203A
产品尺寸 Product size	142x46x110cm	142x46x110cm
包装规格 Packing	1台/箱	1台/箱

全金属喷塑房口车

GUEST ROOM SERVICE CART



D-020



D-021



分隔栏  
separate stall

参数 Specification

型号 Model	D-020	D-021
产品尺寸 Product size	150x50x120cm	142x46x110cm
包装规格 Packing	1台/箱	1台/箱

不锈钢架钢木房口车

GUEST ROOM SERVICE CART



D-019

参数 Specification

型号 Model	D-019
产品尺寸 Product size	135x46x115cm
包装规格 Packing	1台/箱

圆管布草车

ROUND TUBE LINEN TRUCK



D-023



D-024

参数 Specification

型号 Model	D-023	D-024
产品尺寸 Product size	98x58x89cm	65x45x83cm
包装规格 Packing	1台/箱	1台/箱

圆管布草车

ROUND TUBE LINEN TRUCK



D-026



D-027

参数 Specification

型号 Model	D-026	D-027
产品尺寸 Product size	92x56x89cm	68x59x105cm
包装尺寸 Packing size	96.5x11x63cm	96.5x11x63cm
包装规格 Packing	1台/箱	1台/箱

### 玻璃钢布草车

FRP LINEN TRUCK



D-029  
(小号)



D-028  
(大号)

参数 Specification

型号 Model	D-029	D-028
产品尺寸 Product size	90x70x75cm	100x80x83cm
容量 Capacity	0.5m³	0.7m³

### 布草车

LINEN TRUCK



D-030A  
(小号)



D-030B  
(大号)

参数 Specification

型号 Model	D-030A	D-030B
产品尺寸 Product size	101x71x75cm	131x91x79cm

### 洗衣房车

LAUNDRY CART



D-025B



D-025A

参数 Specification

型号 Model	D-025B	D-025A
产品尺寸 Product size	113x73x83cm	124x73x83cm



清洁工具系列  
CLEANING TOOL SERIES

## 卓越的性能

确保卫生和安全的環境

- 优质的超细纤维材质,有效清除细菌
- 有效减少交叉感染
- 可经受高达500次的商业洗涤

## 完整的系统

实现工作效率和产值的最大化

- 相比于传统拖布,化学清洁剂的使用量减少达95%
- 相比于传统拖布,用水量减少达90%
- 相比于传统的细绳拖布,清洁地板的速度提高3倍以上
- 有效减轻清洁人员的疲劳
- 独特的创新清洁工具,全面提高工作效率
- 具备最佳的使用寿命,耐用性强

## 培训和支持

为客户提供最周到的服务

- 专业的清洁系统培训服务
- 清洁操作程序的详细指导
- 全面的八大清洁系统培训
- 持续的培训支持

## PROVEN PERFORMANCE

TO ENSURE HEALTHY, SAFE ENVIRONMENTS

- Superior microfiber proven to remove microorganisms
- Helps reduce cross-transmission
- Withstands up to 500 commercial launderings
- Patents pending

## COMPLETE SYSTEM

TO MAXIMIZE PRODUCTIVITY AND VALUE

- Reduces chemical consumption up to 95% vs. traditional mopping
- Reduces water consumption up to 90% vs. traditional mopping
- Cleans floors more than 3 times faster than traditional string mops
- Proven to reduce worker strain
- Unique innovative tools to maximize productivity
- Features legendary Goodpingao durability

## TRAINING & SUPPORT

TO DELIVER OPTIMAL RESULTS

- Cleaning system of professional training services
- Detailed guidance for cleaning procedures
- Eight cleaning system comprehensive training
- Continuous training support

在热水或冷水中均可配合

## 清洁剂

一起使用

BLEACH-

# SAFE

IN HOT & COLD WATER

相比于其他拖布  
地面清洁度提高

# 45%

CLEANS FLOORS  
45% better than  
string mops

特有锯齿形纺织技术  
每块拖布中超细纤维含量增加

# 17%

PROPRIETARY ZIG-ZAG  
WEAVE PACKS 17%  
more microfiber  
in every mop

比微纤拖布  
清洁地面凡效果好

# 25%

BETTER THAN STRINGMOPS  
25% better than  
conventional  
microfiber flat mops

有效清除

# 99.9%

以上的细菌

(标准细绳拖布只能清除67%的细菌)

PROVEN TO  
REMOVE

# 99.9%

OF MICROORGANISMS



# ChaoBao® 超宝 清洁专家 超宝集团 CLEANING EXPERT

## 除垢效果更佳

对于拖把而言

- 可调节控制水分留存量
- 最优化的挤干性
- 挤干过程中脱尘性更高

## 创造更洁净的水源

- 通过清洁桶转动使污水落入过滤桶
- 通过直立清洁桶使净水滤回至主桶
- 极佳的过滤器能够有效控制污物

### OPTIMIZED TEXTILES FOR DIFFERENT ENVIRONMENTS

- Superior dirt removal in office buildings
- Reach into grout lines in restaurants
- Capture large debris in schools

### REMOVES MORE DIRT FROM THE MOP

- Adjustable rollers control liquid retention
- Optimized wringing efficiency
- Wringing action removes more dirt from the mop



## 标准型大堂尘推

STANDARD LOBBY MOP

- 纱线含棉量高, 股束紧密, 集尘能力强
- 能经得起反复洗涤, 不易散脱
- 合成纤维质料背衬, 耐磨性高, 易磨损部位特设加厚层, 经久耐用。

- The yarn has a high content of cotton. The strands are closely made. It is good at collecting dust
- Repeating washing won't make it loose
- The back lining is made of synthetic fibre. It is highly abrasion proof. The part that is easy to wear is thickened, allowing along use

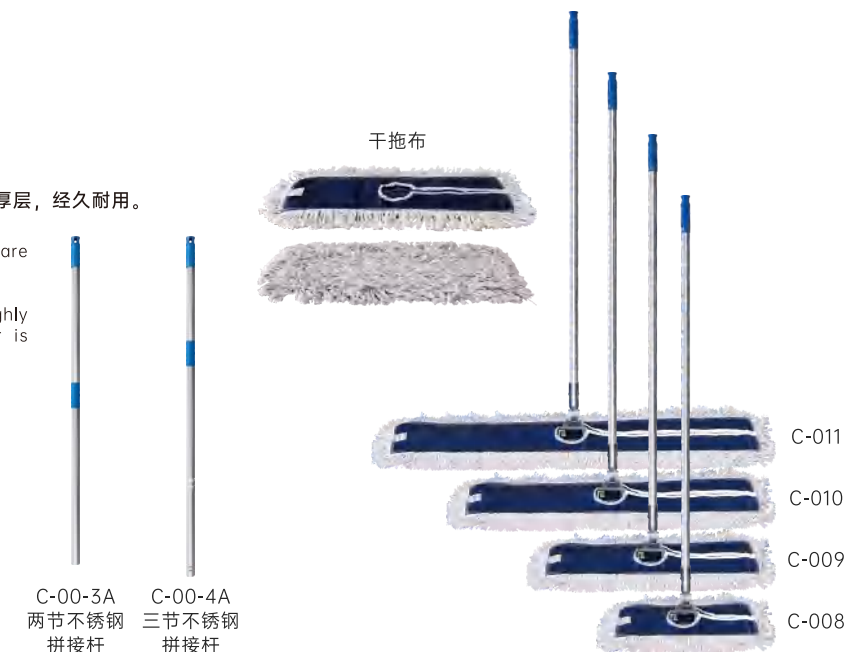

参数 Specification

型号 Model	C-008	C-009	C-010	C-011	C-00-3A	C-00-4A
产品尺寸 Product size	16" 40x16cm	24" 60x16cm	36" 90x16cm	42" 110x16cm	2.5x123cm	2.5x126cm
包装尺寸(不含杆) Packing size	47x39x30cm	66x39x32cm	96x39x30cm	116x39x32cm	/	/
包装数量 Package	25个/箱	25个/箱	25个/箱	25个/箱	15个/箱 (C-008是20个/箱)	15个/箱 (C-008是20个/箱)

## 豪华型大堂尘推

LUXURY LOBBY MOP

- 纱线含棉量高, 股束紧密, 集尘能力强
- 能经得起反复洗涤, 不易散脱
- 合成纤维质料背衬, 耐磨性高, 易磨损部位特设加厚层, 经久耐用。

- The yarn has a high content of cotton. The strands are closely made. It is good at collecting dust
- Repeating washing won't make it loose
- The back lining is made of synthetic fibre. It is highly abrasion proof. The part that is easy to wear is thickened, allowing along use

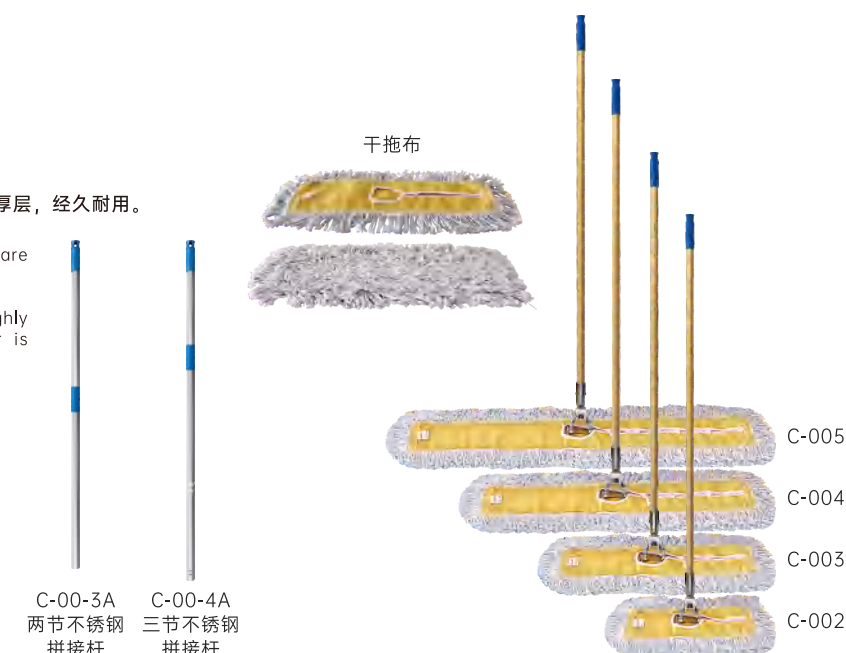

参数 Specification

型号 Model	C-002	C-003	C-004	C-005	C-00-3A	C-00-4A
产品尺寸 Product size	16" 40x16cm	24" 60x16cm	36" 90x16cm	42" 110x16cm	2.5x123cm	2.5x126cm
包装尺寸(不含杆) Packing size	47x39x30cm	66x39x32cm	96x39x30cm	116x39x32cm	/	/
包装数量 Package	25个/箱	25个/箱	25个/箱	25个/箱	15个/箱 (C-002是20个/箱)	15个/箱 (C-002是20个/箱)

### 标准型 微纤尘推

STANDARD ACRYLIC DUST MOP

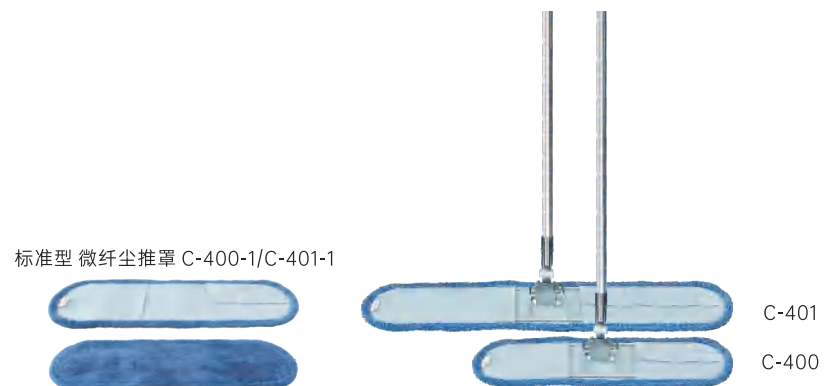

参数 Specification

型号 Model	C-400/C-400-1	C-401/C-401-1
产品尺寸 Product size	24"	36"
包装数量 Package	25个/箱(25Pcs/CTN)	25个/箱(25Pcs/CTN)

### 豪华型 微纤尘推

LUXURY ACRYLIC DUST MOP

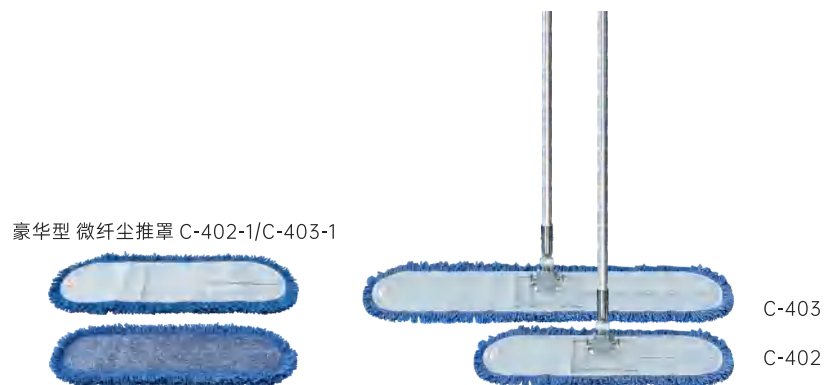

参数 Specification

型号 Model	C-402/C-402-1	C-403/C-403-1
产品尺寸 Product size	24"	36"
包装数量 Package	25个/箱(25Pcs/CTN)	25个/箱(25Pcs/CTN)

### 豪华型干拖

DUST MOP

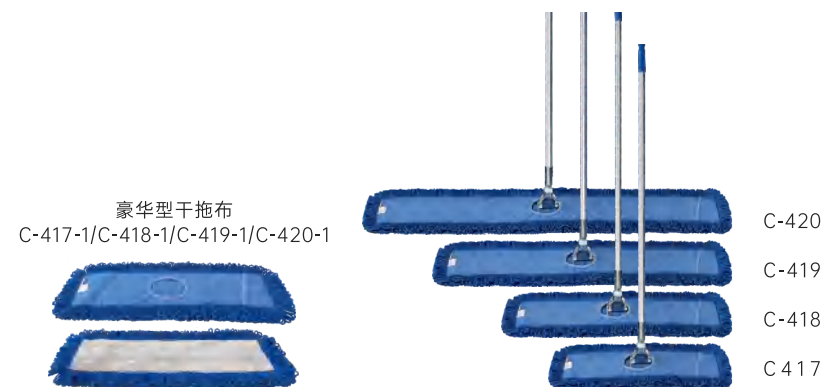

参数 Specification

型号 Model	C-417/C-417-1	C-418/C-418-1	C-419/C-419-1	C-420/C-420-1
产品尺寸 Product size	52.6x14.5x1.3cm	71.1x14.5x1.3cm	101.6x14.5x1.3cm	132.1x14.5x1.3cm

### 铝板平推

ALUMINUM PLATE PUSH FLAT

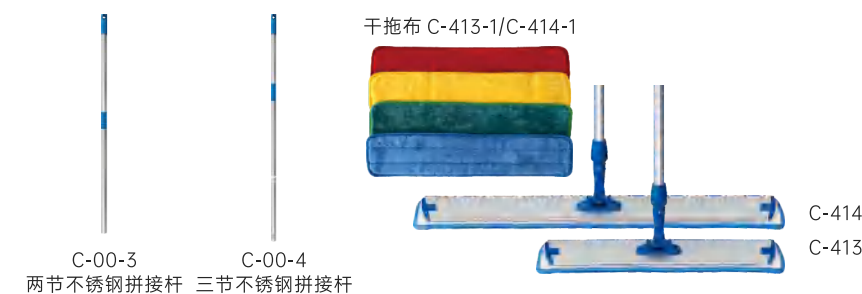

参数 Specification

型号 Model	C-413	C-414	C-413-1	C-414-1	C-00-3	C-00-4
产品尺寸 Product size	43x13x145cm	63x13x145cm	43x13cm	63x13cm	2.5x123cm	2.5x126cm
包装数量 Package	10个/箱	10个/箱	/	/	20个/箱	20个/箱

### 干湿两用微纤平拖18"

WET AND DRY USING MICROFIBER FLAT MOP CLOTH

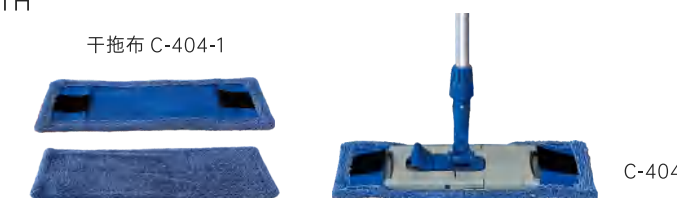

参数 Specification

型号 Model	C-404	C-404-1
产品尺寸 Product size	42x14x159cm	42x14cm
包装数量 Package	/	100个/箱(100Pcs/CTN)

### 干湿两用微纤平拖

WET AND DRY USING MICROFIBER FLAT MOP CLOTH

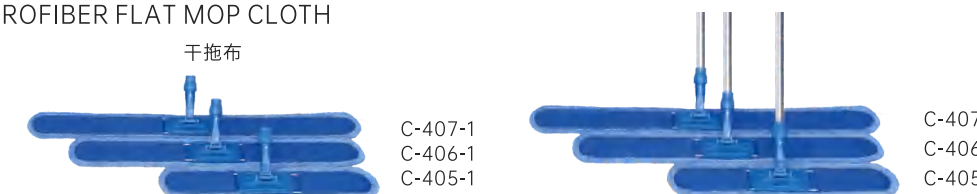

参数 Specification

型号 Model	C-405-1	C-406-1	C-407-1
产品尺寸 Product size	24"	36"	42"

### 免手洗拖把

FLOOR BRUSH

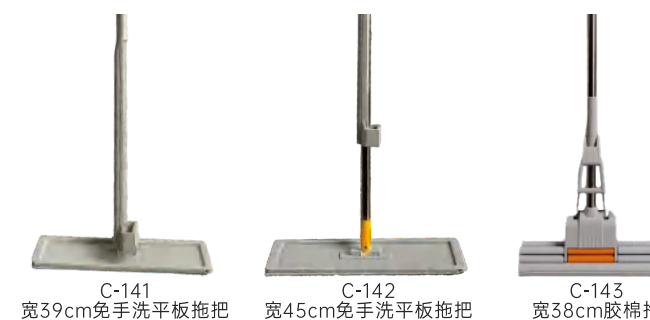

参数 Specification

型号 Model	C-141	C-142	C-143
产品尺寸 Product size	143x33x37cm	128.5x38x26cm	116x40x21cm
包装数量 Package	36个/箱(36Pcs/CTN)	24个/箱(24Pcs/CTN)	12个/箱(12Pcs/CTN)

## 如何选择好的拖把 WET MOP SELECTION GUIDE

请根据以下指南，为您的地板选择最适合的拖把

Use the following guide to choose the best Chaobao Commercial Products Wet Mops for your facility

环境 ENVIRONMENT	洗涤能力 LAUNDERABILITY	乙烯基地砖、层压地板及平滑瓷砖地板 VINYL TILE, LAMINATE, SMOOTH CERAMIC TILE	滑地砖、水磨石、铺路及方形石板 ANTI-SLIP TILE, TERRAZZO, PAVER & QUARRY STONE	橡胶、硬木、平滑混凝土 RUBBER, HARDWOOD, SMOOTH CONCRETE
医疗设施 HEALTHCARE FACILITIES	优质可洗涤拖把 标准可洗涤拖把 不可洗涤/即弃型拖把 Premium Launderable Standard Launderable Non-Launderable/Disposable	齐尾人造纤维拖把 Cut-End Rayon	粗糙地板拖把 Synthetic Blend	
教育设施 EDUCATIONAL FACILITIES	优质可洗涤拖把 标准可洗涤拖把 不可洗涤/即弃型拖把 Premium Launderable Standard Launderable Non-Launderable/Disposable	经济棉质拖把 Economy Cotton	粗糙地板拖把 Synthetic Blend	经济棉质拖把 Economy Cotton
工业及商业地区 INDUSTRIAL & COMMERCIAL	优质可洗涤拖把 标准可洗涤拖把 不可洗涤/即弃型拖把 Premium Launderable Standard Launderable Non-Launderable/Disposable	齐尾棉质拖把 Cut-End Cotton	粗糙地板拖把 Synthetic Blend	无圈形绳头棉质拖把 Cut-End Cotton
餐饮服务 FOODSERVICE	优质可洗涤拖把 标准可洗涤拖把 不可洗涤/即弃型拖把 Premium Launderable Standard Launderable Non-Launderable/Disposable	齐尾混合纤维拖把 Cut-End Cotton	粗糙地板拖把 Synthetic Blend	合成混合纤维拖把 Ynthetic Blend
办公室大楼 OFFICE BUILDINGS	优质可洗涤拖把 标准可洗涤拖把 不可洗涤/即弃型拖把 Premium Launderable Standard Launderable Non-Launderable/Disposable	齐尾棉质拖把 Cut-End Cotton		齐尾棉质拖把 Cut-End Cotton
酒店服务 HOSPITALITY	优质可洗涤拖把 标准可洗涤拖把 不可洗涤/即弃型拖把 Premium Launderable Standard Launderable Non-Launderable/Disposable	齐尾混合纤维拖把 Cut-End Cotton	粗糙地板拖把 Synthetic Blend	齐尾混合纤维拖把 Cut-End Blend



### 标准型压紧式地拖

#### STANDARD PRESSING MOP

铝合金杆配吸水拖布，高脱水强承重耐腐，多场景适用

- 铝合金拖把杆，强韧耐用且轻便，操作省力
- 杆身承重超10kg，抗压不易变形损坏
- 耐化学腐蚀，延长使用寿命，降低使用成本

Aluminum alloy rod with absorbent mop, high dehydration, strong load-bearing, corrosion resistance, and multi-scene applicable

- Aluminum alloy mop handle, strong, durable and lightweight, easy to operate
- The handle can bear a weight of over 10kg resistant to pressure and not easy to deform or damage
- Withstands chemical corrosion, extends service life, and reduces use costs



C-208

C-211

型号 Model	说明 Description	颜色 Color
C-208	标准型压紧式地拖 Standard pressing mop	白 White
C-211	标准型压紧式地拖头 Standard pressing mop	蓝 Blue

## 地拖头 (蜡拖)

MOP HEAD

### 混纺纤维纱线可大量吸收和释放

- 微蓝白粗纱使用有色标的打蜡拖把易于辨识
- 环形末端和纱质尾带减少拖尾痕迹
- 结实紧密的四股纱线不易于掉毛
- 四色标识, 可区分不同区域使用

### Blend fiber absorb and release hugely

- White blue makes easier identification
- Ring end and gauze tail make less drag trace
- Well-knit 4 plies yarn makes less hair slip
- 4 colors identifications, for different area using



型号 Model	说明 Description	颜色 Color
C-013E	标准型地拖头 Standard mop head	白、黄、绿、蓝、红 White, Yellow, Green, Blue, Red

## 地拖头 (水拖)

MOP HEAD

### 更好的吸湿性能, 更持久耐用, 四色系统, 使用更方便

- 微纤和杀菌棉纱混合而成
- 可洗涤, 不会收缩变形
- 与传统混合纤维拖把相比, 耐用性高达2倍
- 洗涤次数也多达2倍四色标识, 可区分不同区域使用
- 可与所有传统的湿拖把手柄和拖头配套使用
- 极佳的洗涤性: 洗涤次数可高达100次

### Better moisture absorption performance, lasting and durable, four color system, convenient using

- Synthetic microfiber and sterilization cotton
- Can be washed, no shrinkage and transformation
- Compare with traditional synthetic fabric mop, the durability is double, washing times is more than double
- 4 colors identifications for different area
- Match with traditional mop handle and mop fixture
- Perfect washing performance: more than 100 times



型号 Model	说明 Description	颜色 Color
C-013F	豪华型地拖头 Luxury mop head	白 White
C-013G	B型地拖头 B mop head	白 White
C-208-1	标准型压紧式地拖拖头 Standard pressing mop head	白 White
C-211-1	标准型压紧式地拖拖头 Standard pressing mop head	蓝 Blue

## 标准型地拖 (蜡拖)

STANDARD TYPE FLOOR MOP

- 铝合金杆轻便强韧 (承重超 10kg), 棉线拖头吸水去渍
- 杆长可调、手柄防滑, 拖头灵活无死角, 兼容多地面, 部分可折叠收纳
- 高性价比, 拖头易拆洗, 铝杆耐腐, 减少更换频率

- Aluminum alloy rod is lightweight and strong (with a load-bearing capacity of over 10kg), the cotton rope mop head absorb water and removes stains
- The rod length is adjustable, the handle is slip-resistant, the mop head is flexible and no dead ends, compatible with multiple floors, and some can be folded and stored
- High cost performance, easy to disassemble and wash the mop head, aluminum rod corrosion resistant, and reduces the frequency of replacement



C-00-2 C-00-3 C-00-4 C-014 C-203 C-201

型号 Model	说明 Description	颜色 Color	包装尺寸 Packing size
C-00-2	标准型地拖杆 Standard drag rod	银 Silver	2.5x122cm
C-00-3	两节不锈钢拼接杆 Two-section stainless steel splicing rod	银 Silver	2.5x123cm
C-00-4	三节不锈钢拼接杆 Three-section stainless steel telescopic rod	银 Silver	2.5x126cm
C-014	标准型地拖 Standard mop head	白 White	/
C-203	标准型压紧式地拖 Standard pressing mop	白 White	/
C-201	标准型夹紧式地拖 Standard clamping mop	白 White	/

## 豪华型地拖 (水拖)

STANDARD TYPE FLOOR MOP

- 强化铝杆承重强、防锈耐腐, 高密度棉线拖头去渍优, 可拆卸降低成本
- 拖头软不刮地, 适配多场景
- 防滑柄好握持, 拖头易洗、杆易收纳

- Strong aluminum rod with strong load-bearing capacity, rust-proof and corrosion-resistant, high-density cotton line mop head for excellent stain removal detachable to reduce cost
- Soft mop head that does not scratch the ground, suitable for multiple scenarios
- Anti-slip handle for easy grip, mop easy to wash, rod easy to store



C-00-1 C-00-3 C-00-4 C-013 C-204 C-202

型号 Model	说明 Description	颜色 Color	包装尺寸 Packing size
C-00-1	豪华型地拖杆 Luxury drag rod	金 Golden	2.5x125cm
C-00-3	两节不锈钢拼接杆 Two-section stainless steel splicing rod	银 Silver	2.5x123cm
C-00-4	三节不锈钢拼接杆 Three-section stainless steel telescopic rod	银 Silver	2.5x126cm
C-013	豪华型地拖 Luxury mop head	白 White	/
C-204	豪华型压紧式地拖 Luxury pressing mop	白 White	/
C-202	豪华型夹紧式地拖 Luxury clamping mop	白 White	/

## 夹头

CLIP

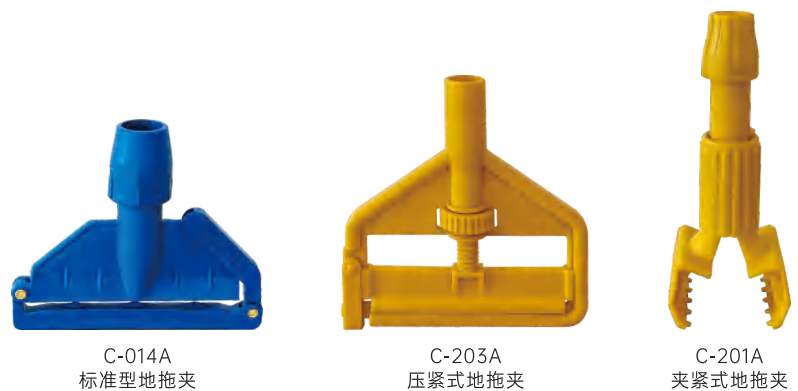

C-014A  
标准型地拖夹

C-203A  
压紧式地拖夹

C-201A  
夹紧式地拖夹

### 参数 Specification

型号 Model	C-014A	C-203A	C-201A
产品规格 Measurement	54x39x15cm	/	/
包装数量 Package	50个/箱 (50Pcs/CTN)	/	50个/箱 (50Pcs/CTN)
颜色 Color	●	●	●

## 拾捡器

PICK UP TOOLS



C-300A

C-300B

C-300C

C-301A

C-301B

C-301C

### 参数 Specification

型号 Model	C-300A	C-300B	C-300C
产品规格 Measurement	100cm	70cm	40cm
包装规格 Carton dimension	98x41x23cm	71.5x41x12cm	42.5x36x20cm
包装数量 Package	24个/箱 (24Pcs/CTN)	24个/箱 (24Pcs/CTN)	24个/箱 (24Pcs/CTN)
颜色 Color	● ●	● ●	● ●

### 参数 Specification

型号 Model	C-301A	C-301B	C-301C 可折叠
产品规格 Measurement	100cm	83cm	83cm
颜色 Color	●	●	●



### 新款五色扫把

BROOM



C-122

#### 参数 Specification

型号 Model	C-122
产品尺寸 Product size	135x30x20cm
颜色 Color	● ● ● ● ●

### 短柄扫把/小扫把

BROOM



C-022  
短柄扫把

C-139  
小扫把

C-136  
小扫把

#### 参数 Specification

型号 Model	C-022	C-139	C-136
产品尺寸 Product size	93x30x2cm	90x30x2cm	90x18x3cm
包装规格 Carton dimension	92x24x20cm	111x30x12cm	扫把头52x42x32cm, 杆77x28x17cm
包装数量 Package	30个/箱(30Pcs/CTN)	12个/箱(12Pcs/CTN)	扫把头30个/箱, 杆60支/箱

### 长柄扫把/大扫把

BROOM



C-021  
长柄扫把

C-137  
大扫把(硬毛)

C-137B  
大扫把(软毛)

#### 参数 Specification

型号 Model	C-021	C-137	C-137B
产品尺寸 Product size	125x32x3cm	136x37x3cm	136x37x3cm
包装规格 Carton dimension	113.5x29.5x29cm	80x33x23cm	80x33x23cm
包装数量 Package	30套/箱(30Pcs/CTN)	24个/箱(24Pcs/CTN)	24个/箱(24Pcs/CTN)

### 防风垃圾铲

WINDPROOF RUBBISH SHOVEL



产品特点



C-139/019E

#### 参数 Specification

型号 Model	C-139(扫把)	C-019E(垃圾铲)	C-139/019E(套装)
产品尺寸 Product size	92x32x2cm	/	/
颜色 Color	● ●	● ●	● ●

### 垃圾铲

RUBBISH SHOVEL



C-019B  
塑料垃圾铲

C-019D/139  
塑料防风垃圾铲

C-147/148  
扫把垃圾铲套装

#### 参数 Specification

型号 Model	C-019B	C-019D/139	C-147/148
产品尺寸 Product size	31x34x12cm	扫把92x32x2cm	扫把80x31x3cm
包装规格 Carton dimension	53x41x40cm	/	97.5x38x35.5cm
包装数量 Package	20个/箱(20Pcs/CTN)	7套/箱(7Pcs/CTN)	24个/箱(24Pcs/CTN)
颜色 Color	/	● ●	/

### 垃圾铲

RUBBISH SHOVEL



C-019  
塑料垃圾铲

C-019C  
塑料防风垃圾铲

C-019D  
塑料防风垃圾铲

C-020  
铁防风垃圾铲

#### 参数 Specification

型号 Model	C-019	C-019C	C-019D	C-020
产品尺寸 Product size	32.3x29x80cm	32.3x29x80cm	32.3x29x80cm	26.5x31x66cm
包装规格 Carton dimension	79x34x68.5cm	79x34x68.5cm	79x34x68.5cm	66x64x28cm
包装数量 Package	12个/箱(12Pcs/CTN)	12个/箱(12Pcs/CTN)	12个/箱(12Pcs/CTN)	10个/箱(10Pcs/CTN)



### 五面地板刷

FLOOR BRUSH

可从不同类型的地板表面抓取更大的灰尘

- 聚丙烯刷毛与天然龙舌兰刷毛使用寿命长，可清扫粗糙木质地板表面与光滑地板表面的灰尘
- 倾斜角度的支柱可增加支持与稳定性
- 手柄需要单独购买

Grab bigger dust from different floor

- PP hair and natural maguey hair has long using life, can clean rough wooden floor and smooth floor
- Inclined angle proved supporting and stability
- Handle need to be purchase additionally

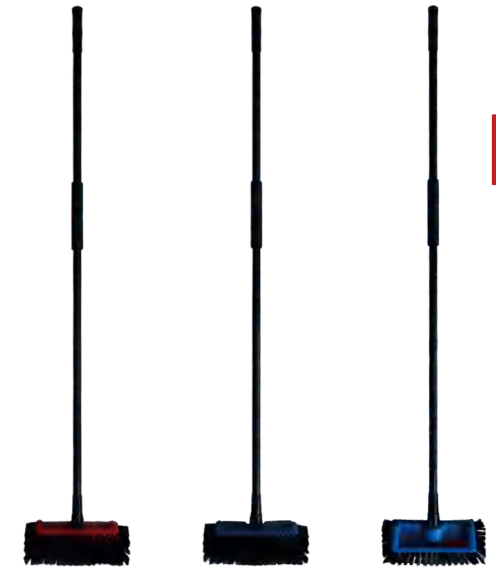

C-147

#### 参数 Specification

型号 Model	C-147
产品尺寸 Product size	16.1x3x1cm
包装尺寸 Packing size	152x18x13.5cm
包装数量 Package	20个/箱(20Pcs/CTN)

### 地板刷

FLOOR BRUSH

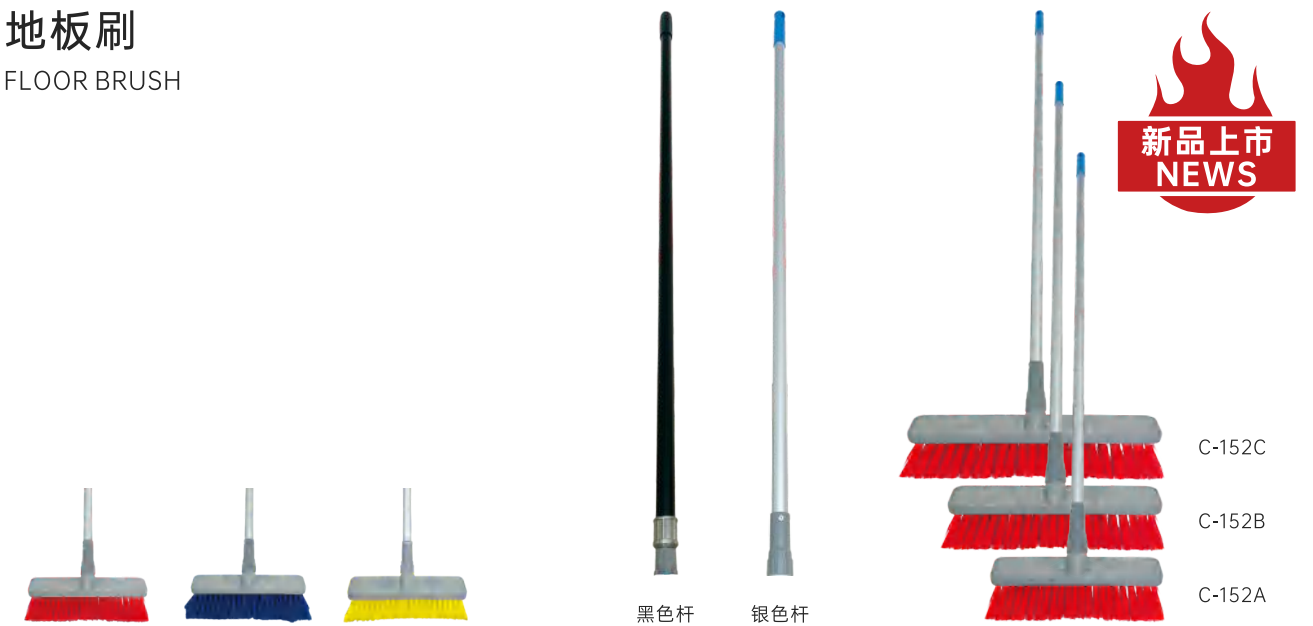

C-152C

C-152B

C-152A

黑色杆 银色杆

#### 参数 Specification

型号 Model	C-152A	C-152B	C-152C
产品尺寸 Product size	124x30cm	124x45cm	124x60cm
颜色 Color	● ● ●	● ● ●	● ● ●

### 地板刷

FLOOR BRUSH



参数 Specification

型号 Model	C-146	C-131	C-131B	C-038	C-039
产品尺寸 Product size	/	10"25cm	18"45cm	18"45cm	24"60cm
包装尺寸(不含杆) Packing size	115.3x31x38.5cm	/	/	48x47x30.3cm	61x28x45cm
包装数量 Package	48个/箱	20个/箱	20个/箱	20个/箱	20个/箱

### 地板刷杆

FLOOR BRUSH

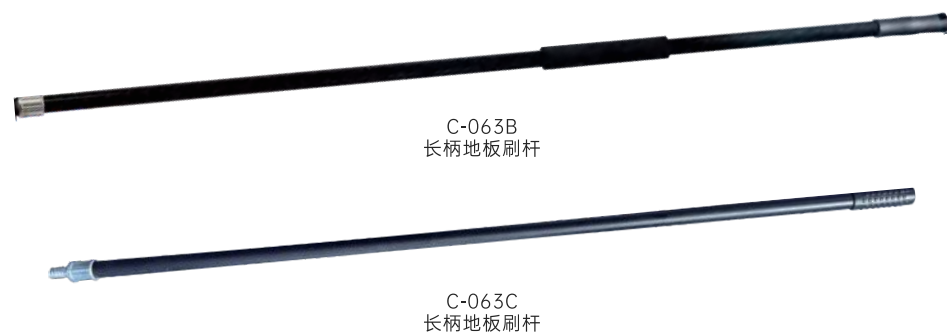

参数 Specification

型号 Model	C-063B	C-063C
产品尺寸 Product size	2.2x150cm	2.2x124cm
包装数量 Package	12个/箱(12Pcs/CTN)	12个/箱(12Pcs/CTN)

### 二节通水洗车刷

WATER FLOW BRUSH

高处外墙、玻璃幕墙清洁轻松完成

- 刷头采用波浪式割毛设计，刷体富有弹性，可防止杂质损伤外墙或玻璃，无论污垢有多厚，本产品均可完成清理，配合超宝清洁剂使用更加方便。
- 铝杆采用伸缩式通水设计，可以连接水管，无需再来回提水，轻轻松松搞定(需单独购买)

Easy clean high wall and glass curtain wall

- Brush head adopt wave cutting, hairs elastic, prevent impurity scratch wall or glass. No matter how much is the dirt, this brush can clean, it will be more convenient if work with chaobao cleaning agent.
- Aluminum rod adopt retractable design, with water channel, can connect water pipe directly, no need life water once and again, it is convenient for operation (need additional purchase)



C-130

参数 Specification

型号 Model	C-130
产品尺寸 Product size	102.5(172)x25x8cm

### 不通水洗车刷

CLEANING BRUSH



C-130B

参数 Specification

型号 Model	C-130B
产品尺寸 Product size	149.5x25x8cm

钢板直绵推水刮

STEEL STRAIGHT SPONGE SQUEEGEE

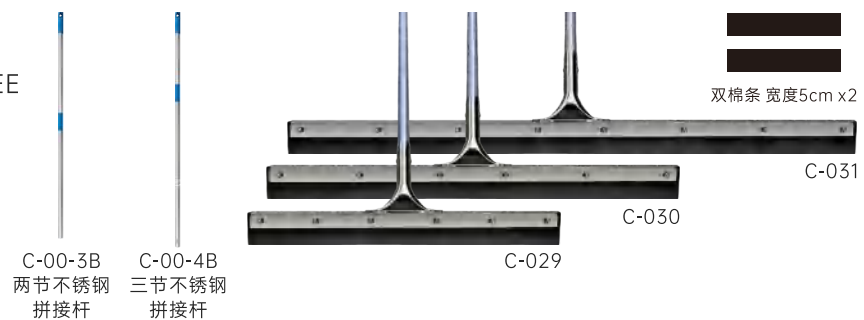

参数 Specification

型号 Model	C-029	C-030	C-031	C-00-3B	C-00-4B
产品尺寸 Product size	18" 45cm	22" 55cm	30" 75cm	2.5x123cm	2.5x126cm
包装尺寸 Packing size	47x27x27.5cm	77x34x22cm	57x27x27.5cm	/	/
包装数量 Package	50个/箱	50个/箱	50个/箱	20个/箱	20个/箱

钢板弯绵推水刮

STEEL CURVED SPONGE SQUEEGEE



参数 Specification

型号 Model	C-033	C-034	C-00-3B	C-00-4B
产品尺寸 Product size	22" 55cm	30" 75cm	2.5x123cm	2.5x126cm
包装尺寸 Packing size	57x22x19cm	76x28x31cm	/	/
包装数量 Package	50个/箱	50个/箱	20个/箱	20个/箱

塑料海绵推水刮

PLASTIC SPONGE SQUEEGEE

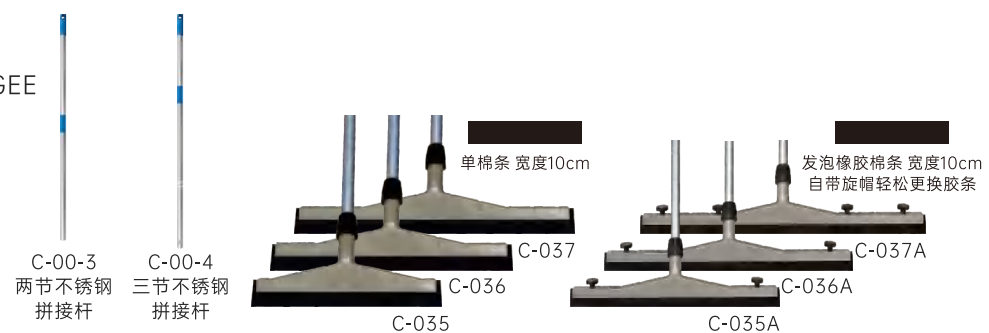

塑料海绵推水刮 Plastic sponge squeegee

型号 Model	C-035	C-036	C-037	C-00-3	C-00-4
产品尺寸 Product size	18" 45cm	22" 55cm	30" 75cm	2.5x123cm	2.5x126cm
包装尺寸 Packing size	50x28x45cm	61x28x41cm	82x28x45cm	/	/
包装数量 Package	20个/箱	20个/箱	20个/箱	20个/箱	20个/箱

可更换塑料海绵推水刮 Plastic sponge squeegee

型号 Model	C-035A	C-036A	C-037A	C-00-3	C-00-4
产品尺寸 Product size	18" 45cm	22" 55cm	30" 75cm	2.5x123cm	2.5x126cm
包装尺寸 Packing size	50x28x45.5cm	61x28x48.5cm	82x28x47.5cm	/	/
包装数量 Package	20个/箱	20个/箱	20个/箱	20个/箱	20个/箱
颜色 Color	● ●	● ●	● ●		

钢板直胶推水刮

STEEL STRAIGHT RUBBER SQUEEGEE

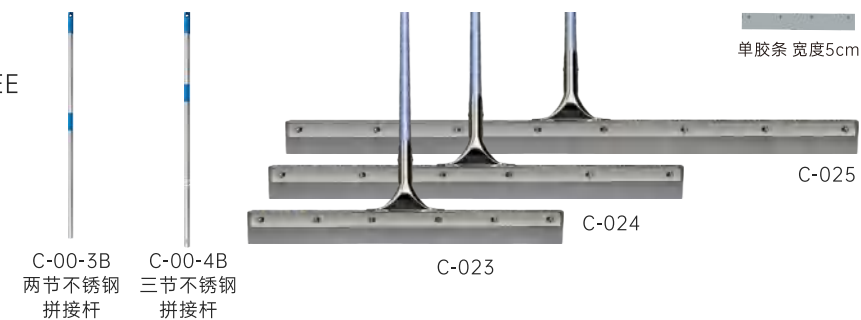

参数 Specification

型号 Model	C-023	C-024	C-025	C-00-3B	C-00-4B
产品尺寸 Product size	18" 45cm	22" 55cm	30" 75cm	2.5x123cm	2.5x126cm
包装尺寸 Packing size	44.5x25.5x12cm	54.5x25.5x12cm	75.5x25.5x12cm	/	/
包装数量 Package	30个/箱	30个/箱	30个/箱	20个/箱	20个/箱

钢板弯胶推水刮

STEEL CURVED RUBBER SQUEEGEE

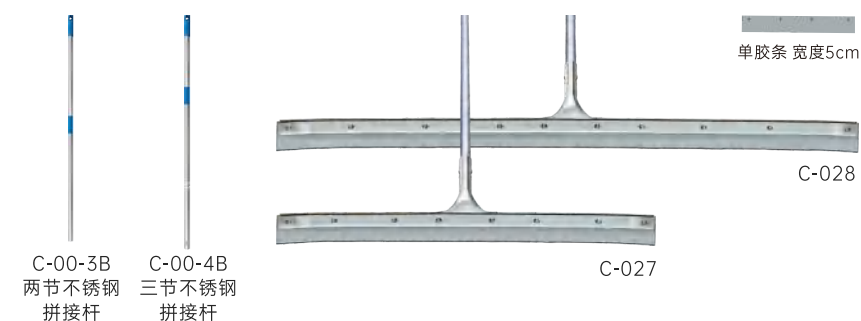

参数 Specification

型号 Model	C-027	C-028	C-00-3B	C-00-4B
产品尺寸 Product size	22" 55cm	30" 75cm	2.5x123cm	2.5x126cm
包装尺寸 Packing size	54x25.5x13.5cm	74x25.5x13.5cm	/	/
包装数量 Package	30个/箱	30个/箱	20个/箱	20个/箱

铝合金/不锈钢推水器

ALUMINUM ALLOY/STAINLESS STEEL WATER PUSHER



不锈钢推水器 Stainless steel water pusher

型号 Model	C-027A
产品尺寸 Product size	85x135cm
包装尺寸 Packing size	141x13x31cm
包装数量 Package	2个/箱(2Pcs/CTN)

铝合金推水器 Aluminum alloy water-pushed propeller

型号 Model	C-028A
产品尺寸 Product size	96x150cm
包装尺寸 Packing size	150x43x14cm
包装数量 Package	2个/箱(2Pcs/CTN)



**C-070 C-070D**  
**C-071 C-071D**  
**C-072 C-072D**

**涂水器**  
GLASS WATER SCRAPE

**白色毛头涂水器** White mop head water applicator

产品规格 Measurement	C-070 14"35cm C-071 16"40cm C-072 18"45cm
包装规格 Carton dimension	C-070 76x42x25cm C-071 78x48x24cm C-072 80x54x24cm
包装数量 Package	50套/箱 (50Suites/Box)
手柄颜色 Handle color	● 黑色 black ● 蓝色 blue



**蓝色毛头涂水器** Blue mop head water applicator

产品规格 Measurement	C-070D 14"35cm C-071D 16"40cm C-072D 18"45cm
包装规格 Carton dimension	C-070 76x42x25cm C-071 78x48x24cm C-072 80x54x24cm
包装数量 Package	50套/箱 (50Suites/Box)
手柄颜色 Handle color	● 黑色 black ● 蓝色 blue

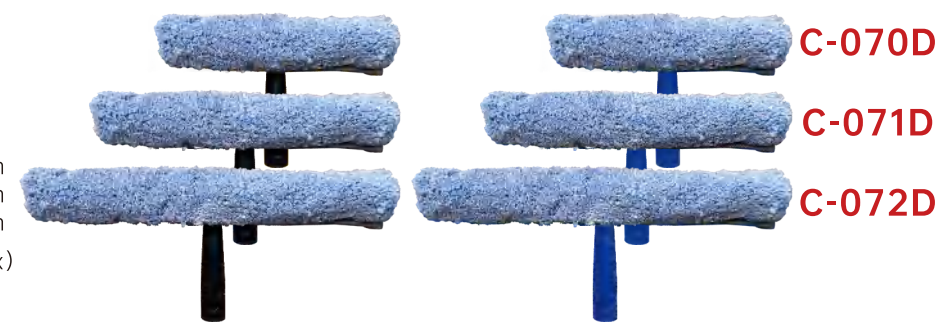

**C-074 C-070D**  
**C-075 C-071D**  
**C-076 C-072D**

**涂水器毛头**  
GLASS WATER SCRAPE

**白色毛头** White mop head water applicator

产品规格 Measurement	C-074 14"35cm C-075 16"40cm C-076 18"45cm
包装数量 Package	10个/包 (10Bins/Bag)



**蓝色毛头** Blue mop head water applicator

产品规格 Measurement	C-070D 14"35cm C-071D 16"40cm C-072D 18"45cm
包装数量 Package	10个/包 (10Bins/Bag)



**C-074A  
C-075A  
C-076A**

**普通T柄**  
NORMAL T HANDLE

产品规格 Measurement  
C-074A 14"35cm  
C-075A 16"40cm  
C-076A 18"45cm

包装数量 Package  
10个/包 (10Bins/Bag)

手柄颜色 Handle color  
●黄色 yellow ●绿色 green ●蓝色 blue ●黑色 black



**C-076A  
C-075A  
C-074A**

**C-070-1  
C-070-2  
C-070-3**

**豪华T柄**  
LUXURY T HANDLE

产品规格 Measurement  
C-070-1 14"35cm  
C-070-2 16"40cm  
C-070-3 18"45cm

包装数量 Package  
10个/包 (10Bins/Bag)

颜色 color  
●蓝色 blue ●黑色 black



**C-070-3  
C-070-2  
C-070-1**

**C-071-1  
C-071-2  
C-071-3**

**多角度旋转式T柄**  
HAND SOAP DISPENSER

产品规格 Measurement  
C-071-1 14"35cm  
C-071-2 16"40cm  
C-071-3 18"45cm

包装数量 Package  
10个/包 (10Bins/Bag)

颜色 color  
●蓝色 blue ●黑色 black



可180°旋转  
轻松清洁斜角位置



**C-071-3  
C-071-2  
C-071-1**

**C-077-1  
C-077-2  
C-077-3**

**两用玻璃刮涂水器**  
TWO-IN-ONE GLASS SCRAPER

产品规格 Measurement  
C-077-1 14"35cm  
C-077-2 16"40cm  
C-077-3 18"45cm



**C-077-3  
C-077-2  
C-077-1**

**不锈钢玻璃刮(欧式)**

STAINLESS STEEL GLASS SCRAPER(EUROPEAN STYLE)

产品规格 Measurement  
C-066 10"25cm  
C-067 14"35cm  
C-068 16"40cm  
C-069 18"45cm

包装规格 Carton dimension  
C-066 42.5x36x20cm  
C-067 42.5x36x20cm  
C-068 42.5x36x20cm  
C-069 47x36x20cm

包装数量 Package  
100个/箱 (100Bins/Box)

颜色 Color  
●黑色 black ●蓝色 blue

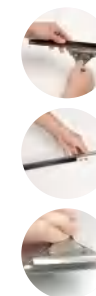

★ 弹簧钢夹 灵活拆卸



**C-069  
C-068  
C-067  
C-066**

**塑料铝合金玻璃刮(欧式)**

GLASS-ALLOY SCRAPER(EUROPEAN STYLE)

产品规格 Measurement  
C-061 10"25cm  
C-062 14"35cm  
C-063 16"40cm  
C-064 18"45cm

包装规格 Carton dimension  
C-061 50x36x24cm  
C-062 50x36x24cm  
C-063 50x36x24cm  
C-064 50x36x24cm

包装数量 Package  
100个/箱 (100Bins/Box)

颜色 Color  
●黑色 black ●蓝色 blue



★ 螺旋固定 灵活拆卸

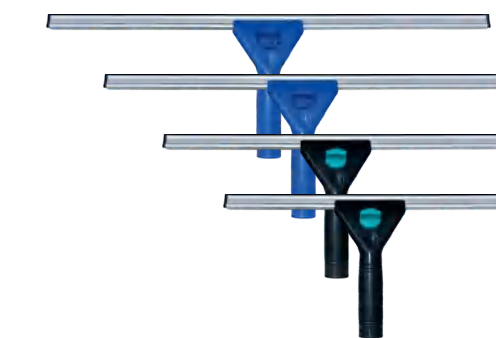

**C-064  
C-063  
C-062  
C-061**

**不锈钢弹簧式玻璃刮(美式)**

STAINLESS STEEL SPRING-TYPE GLASS SCRAPER(AMERICAN STYLE)

产品规格 Measurement  
C-066B 10"25cm  
C-067B 14"35cm  
C-068B 16"40cm  
C-069B 18"45cm

包装规格 Carton dimension  
C-066B 42.5x36x20cm  
C-067B 42.5x36x20cm  
C-068B 42.5x36x20cm  
C-069B 47x36x20cm

包装数量 Package  
100个/箱 (100Bins/Box)

颜色 Color  
●黑色 black ●蓝色 blue

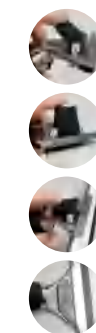

★ 豪华材质 质量保证



**C-069B  
C-068B  
C-067B  
C-066B**

**塑料旋转式玻璃刮(美式)**

PLASTIC ROTATING GLASS SCRAPER(AMERICAN STYLE)

产品规格 Measurement  
C-061D 10"25cm  
C-062D 14"35cm  
C-063D 16"40cm  
C-064D 18"45cm

包装规格 Carton dimension  
C-061D 42.5x36x20cm  
C-062D 42.5x36x20cm  
C-063D 42.5x36x20cm  
C-064D 47x36x20cm

包装数量 Package  
50个/箱 (50Bins/Box)

颜色 Color  
●黑色 black ●蓝色 blue

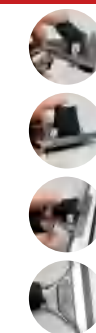

★ 坚固实用 180°旋转



**C-064D  
C-063D  
C-062D  
C-061D**

玻璃刮胶条

RUBBER STRIP OF GLASS SQUEEGEE

产品规格 C-080 42"105cm

Measurement

包装数量 200个/箱 (200pcs/CTN)

Package

颜色 ●黑色 ●蓝色

Color black blue



C-080

塑料铝合金玻璃刮(欧式)

GLASS-ALLOY SCRAPE(EUROPEAN STYLE)

包装数量 200条/箱 (200Strips/CTN)

Package

颜色 ●黑色 ●蓝色 ●绿色 ●黄色

Color black blue green yellow

杆体颜色 ●银色 ●金色

Color silver gold

产品规格 C-044 0.6M 单节 single level

Measurement C-045 1.2M 单节 two level

C-046 1.2M 双节 two level

C-047 2.4M 双节 two level

C-048 3.0M 双节 two level

C-049 3.6M 双节 two level

C-050 4.0M 双节 two level

C-051 4.5M 双节 two level

C-052 3.6M 三节 three level

C-053 4.0M 三节 three level

C-054 4.5M 三节 three level

C-055 6.0M 三节 three level

C-056 8.0M 三节 three level

C-057 9.0M 三节 three level

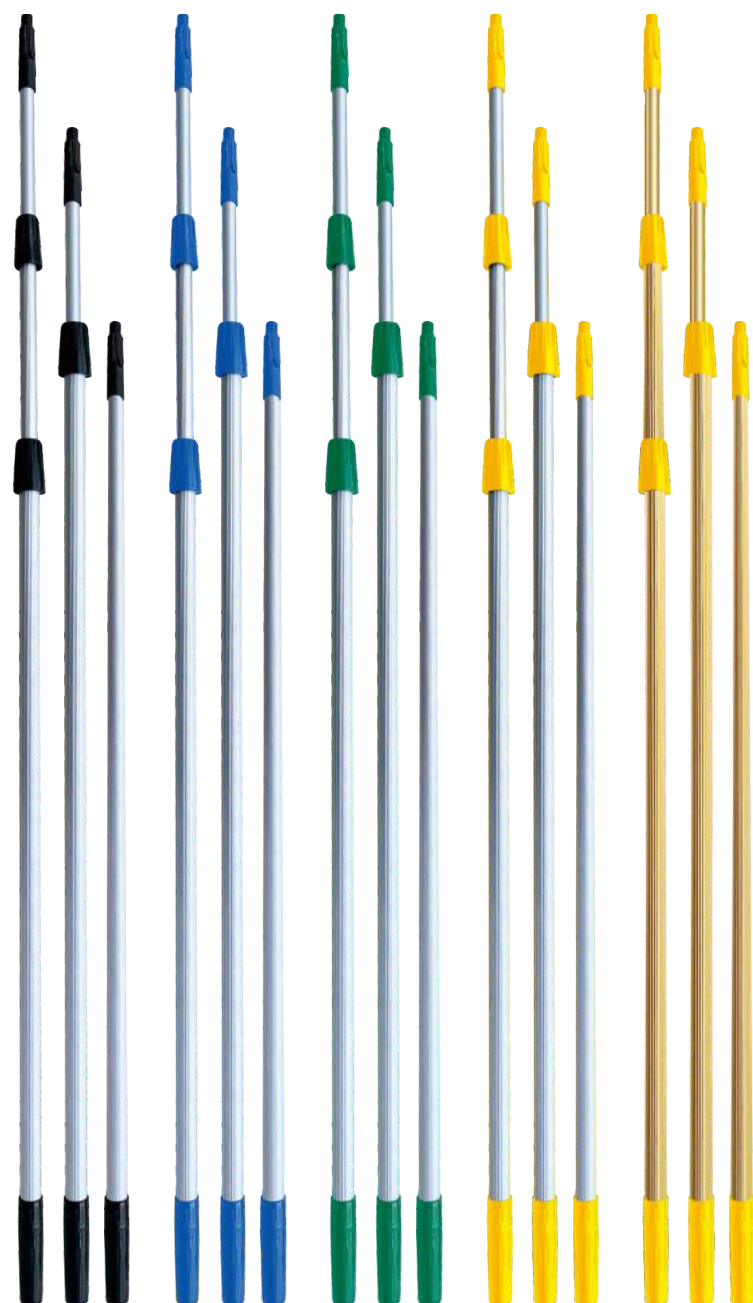

C-041

老虎夹

TIGER CLIP

产品规格 C-041 33x32x28cm

Measurement

包装数量 50个/箱 (50pcs/CTN)

Package

颜色 ●绿色 ●蓝色

Color green blue



C-041

C-042

不锈钢玻璃铲刀

STAINLESS STEEL GLASS KNIFE

颜色 ●黑色 ●蓝色 ●青绿 ●黄色

Color black blue turquoise yellow



C-042

C-058  
C-060  
C-065

不锈钢玻璃铲刀

STAINLESS STEEL GLASS KNIFE

包装数量 100把/箱 (100pcs/CTN)

Package



C-058  
不锈钢玻璃铲刀

C-060  
塑料玻璃铲刀

C-065  
塑料玻璃铲刀

C-017  
C-017C

地板铲刀

GLASS SHOVEL

包装数量 100把/箱 (100pcs/CTN)

Package



C-017  
地板铲刀



C-017C  
长柄铲刀

**C-043** 清洁玻璃工具套装  
GLASS CLEANING KIT

产品规格 Measurement C-043 125x26x7cm



C-043

**C-042B**  
**C-042A**  
**C-017-1** 刀片  
BLADE

包装数量 Package C-042B 200片/包 (200Bins/Bag)  
C-042A 100片/包 (100Bins/Bag)  
C-017-1 100片/包 (100Bins/Bag)



**C-042B**  
不锈钢玻璃铲刀片

**C-042A**  
刀片夹

**C-017-1**  
地板铲刀刀片

**C-107**  
**C-108**  
**C-109** 拖把挂架  
CLEANING TOOL HOLDERS

产品规格 Measurement C-107 2头 28cm  
C-108 3头 44cm  
C-109 4头 58cm

颜色 Color ● 黑色 black ● 蓝色 blue

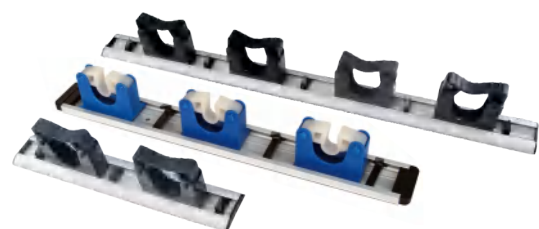

C-107

C-108

C-109

**C-092**  
**C-093** 海绵百洁布  
SPONGE CLOTH

产品规格 Measurement C-092 8.2x10x3cm  
C-093 /  
包装数量 Package 100个/箱 (100pcs/CTN)

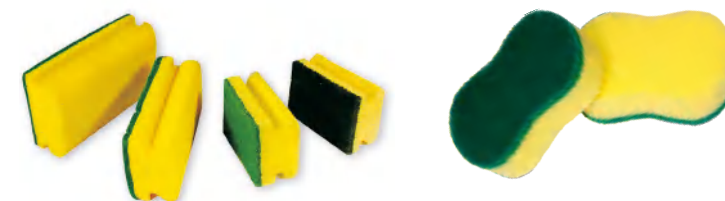

**C-092**  
起坑海绵百洁布

**C-093**  
腰型海绵百洁布

**C-091**  
**C-090** 百洁布  
SPONGE CLOTH

产品规格 Measurement C-091 10x15x0.9cm  
C-090 11.5x14x0.9cm  
包装数量 Package 100个/箱 (100pcs/CTN)



**C-091**  
方形百洁布

**C-090**  
腰型百洁布

**C-097** 手套  
GLOVE

包装规格 Carton dimension C-097 58x37x27cm  
包装数量 Package 200个/箱 (200pcs/CTN)



**C-097(M)**  
防滑橡胶手套M码

**C-097(L)**  
防滑橡胶手套L码

**C-085**  
**C-144**  
**C-145** 清洁刷  
CLEAN BRUSH

包装规格 Carton dimension C-085 /  
C-144 /  
C-145 60x42x30cm  
包装数量 Package C-085 100个/箱 (100pcs/CTN)  
C-144 24个/箱 (24pcs/CTN)  
C-145 48个/箱 (48pcs/CTN)



**C-085**  
挤水型马桶刷

**C-144**  
圆形马桶刷

**C-145**  
方头马桶刷

**C-138**  
**C-138B** **长柄清洁刷**  
CLEAN BRUSH

产品规格 Measurement C-138 50.5x11x7.5cm  
C-138B 50.5x11x7.5cm  
包装数量 Package 40个/箱 (40pcs/CTN)



**C-138**  
长柄清洁刷(软毛)

**C-138B**  
长柄清洁刷(硬毛)

**C-132**  
**C-132B** **短柄清洁刷**  
CLEAN BRUSH

产品规格 Measurement C-132 21x10.5x7.5cm  
C-132B 21x10.5x7.5cm  
包装数量 Package C-132 48个/箱 (48pcs/CTN)  
C-132B 48个/箱 (48pcs/CTN)  
颜色 Color C-132 /  
C-132B ●黑色 black ●蓝色 blue



**C-132**  
短柄清洁刷(软毛)

**C-132B**  
短柄清洁刷(硬毛)

**C-403B**  
**C-087**  
**C-088** **尘扫**  
DUSTER

包装规格 Carton dimension C-403B 10.5x90.5cm  
C-087 53x53x43.5cm  
C-088 52x52x42cm  
包装数量 Package C-087 20个/箱 (20pcs/CTN)



**C-403B**  
尘扫

**C-087**  
圆形尘埃扫

**C-088**  
腰型管道扫

**C-086**  
**C-087A** **清洁刷**  
CLEAN BRUSH

包装数量 Package 100个/袋 (100pcs/CTN)



**C-086**  
浴缸刷

**C-087A**  
杯刷

**C-081**  
**C-082**  
**C-083** **美国高压打气喷壶**  
USA HIGH-PRESSURE SPRAY CAN

包装规格 Carton dimension C-083 66x42x34.5cm  
C-081 56x39.5x46cm  
C-082 56x39.5x58cm  
容量 Capacity C-083 2L  
C-081 5L  
C-082 8L  
包装数量 Package C-083 15个/箱 (15pcs/CTN)  
C-081 6个/箱 (6pcs/CTN)  
C-082 6个/箱 (6pcs/CTN)



**C-083**

**C-081**

**C-082**

**C-084**  
**C-084D** **塑料小喷壶**  
PLASTIC SPRAY CAN

容量 Capacity C-084 550ML  
C-084D 500ML  
包装数量 Package C-084 100个/袋 (100pcs/CTN)  
C-084D /



**C-084**

**C-084D**

**C-084-1**  
**C-084D-1** **塑料小喷壶**  
PLASTIC SPRAY CAN

容量 Capacity C-084-1 550ML  
C-084D-1 500ML  
包装数量 Package C-084-1 100个/袋 (100pcs/CTN)  
C-084D-1 /



**C-084-1**

**C-084D-1**

**C-096B** **工具腰带**  
TOOLS BELT



**C-096B**



★ ★ ★  
**垃圾袋  
生产专家**  
★ ★ ★

## 超宝集团

吹膜部车间成立6周年，车间采用行内先进精密吹膜机、切袋机等设备！已发展成为塑料包装袋行业里初具规模的企业，品质优良，价格实惠！

## 支持定制，质优价廉

我们的生产设备精良，产品线涵盖塑料背心袋，平口式垃圾袋等系列垃圾袋产品。可定制不同尺寸颜色款式，公司产品售往全国各地，可为宾馆、酒店、物业公司、保洁公司、学校、车站、地铁、医院、公园、社区等单位提供高品质的垃圾袋产品。

### 垃圾袋酒店系列

HOTEL SERIES OF GARBAGE BAG

背心袋/可接受定制  
VEST POCKET



尺寸	克重/个	适合的垃圾桶
36x36cm	10	8.5L/15L
33x55cm	11.2	8L

平口袋/可接受定制  
FLAT POCKET

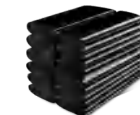

尺寸	克重/个	适合的垃圾桶
45x50cm	6.2	8.5L/15L
60x80cm	16	25L/30L/32L/42L
80x100cm	27	60L/68L/80L/100L
100x120cm	36	80L/100L/120L/168L
120x140cm	55	100L/120L/168L/240L

### 垃圾袋物业系列

GARBAGE BAG PROPERTY SERIES

平口袋/可接受定制  
FLAT POCKET



尺寸	克重/个	适合的垃圾桶
80x100cm	27.5	60L/68L/80L/100L
80x90cm	24	60L/68L/80L
90x100cm	30	80L/100/120L
90x110cm	34	80L/100L/120L
100x120cm	40	80L/100L/120L/168L
120x140cm	55	100L/120L/168L/240L
120x140cm	50	100L/120L/168L/240L
60x80cm	16.5	25L/30L/32L/42L
45x50cm	6.2	10L/8L/15L
70x90cm	21	30L/35L/45L/60L
70x100cm	24	60L/68L/80L



# 超宝集团纸巾用品

## 以洁净实力，守护生活细节

超宝集团旗下核心品类，超宝纸巾用品将严苛的品质标准与人性化设计融入每一张纸巾，为家庭与商业场景提供可靠的洁净解决方案。

### 经营范围

中心抽

大卷纸

擦手纸

纸面巾

卫生纸

纸餐巾

### 产品坚守

不做半木浆，专做原生浆，不做高防纸

### 品牌理念

生产行业标准产品，争做行业标准企业

### 发展目标

致力成为国内商务用纸中高端品牌



看品质——原生木浆



看厂家——源头工厂



看服务——厂家直达

## 全面卫生解决方案，让洁净尽在掌握

凭借多年深耕行业的实战经验，我们始终以“高品质产品+专业化服务”为核心，为每一位客户量身打造安全稳定的定制化解决方案。从需求响应到落地交付全程护航，助力商业物业突破价值瓶颈、实现综合增值，稳步迈向更具竞争力的发展新局。



### 全程无忧供货

强大供应链支持，货源充足不断档



### 支持定制

灵活适配需求，合作无门槛更轻松



### 高额回报 轻松创收

高毛利产品线，轻松实现财富增长



### 独家区域权益

严格区域划分，全面杜绝恶性竞争



### 高频迭代新品

专业研发团队，打造差异化竞争力



### 全网营销支持

线上线下联动，全方位品牌曝光

## 厂家直销，优质纸品

源头直供，选对真厂家！

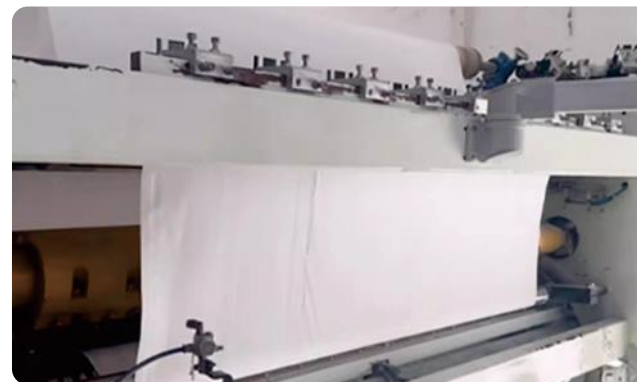

### 超宝擦手纸

FOLDABLE TISSUE

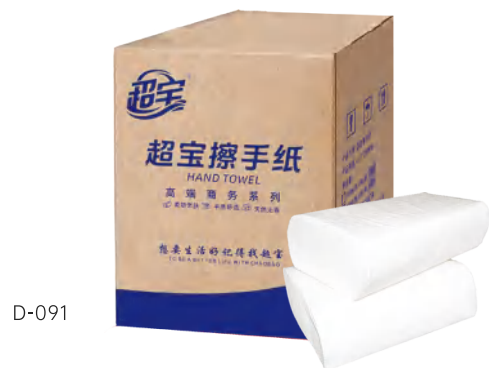

D-091

参数 Specification

型号 Model	D-091-1	D-091-2
产品尺寸 Product size	200抽 21.5x7x16.5cm	150抽 21.5x7x15cm
包装规格 Cortan dimension	35x34x45cm	34x33x45cm
包装数量 Package	20个/箱(20Pcs/CTN)	20个/箱(20Pcs/CTN)

### 超宝大卷纸

PAPER TOWELS



D-092

参数 Specification

型号 Model	D-092-1	D-092-2
产品尺寸 Product size	600g 20.5x9cm	700g 21.5x9cm
包装规格 Cortan dimension	45x45x28cm	45x45x28cm
包装数量 Package	12个/箱(12Pcs/CTN)	12个/箱(12Pcs/CTN)

### 超宝中心抽大卷纸

PAPER TOWELS

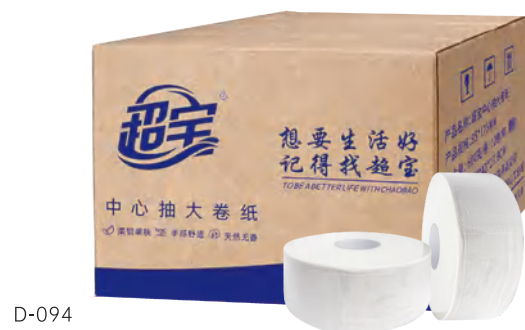

D-094

参数 Specification

型号 Model	D-094-1
产品尺寸 Product size	600g 20x9.5cm
包装规格 Cortan dimension	40.5x40.5x29cm
包装数量 Package	12个/箱(12Pcs/CTN)

### 超宝纸面巾

FLEXIBLE PAPER TOWELS



D-095

参数 Specification

型号 Model	D-095-1	D-095-2	D-095-3	D-095-4
产品尺寸 Product size	80抽 17.5x9x3cm	100抽 17.5x9x4cm	90抽 17.5x9x3.5cm	50抽 17.5x9x2cm
包装规格 Cortan dimension	47x34x32cm	48x35x38cm	48x36x34cm	50x36x36cm
包装数量 Package	120个/箱(120Pcs/CTN)	100个/箱(100Pcs/CTN)	100个/箱(100Pcs/CTN)	200个/箱(200Pcs/CTN)

### 超宝卫生纸

FLEXIBLE TISSUE



D-096

参数 Specification

型号 Model	D-096-1	D-096-2	D-096-3
产品尺寸 Product size	100g 9x10cm	80g 7x10cm	50g 6x10cm
包装规格 Cortan dimension	40x34x50cm	33x40x50cm	80x52x20cm
包装数量 Package	100个/箱(100Pcs/CTN)	100个/箱(100Pcs/CTN)	192个/箱(192Pcs/CTN)

### 超宝纸餐巾

NAPKIN



D-097

参数 Specification

型号 Model	D-097-1
产品尺寸 Product size	90抽 12x12x5cm
包装规格 Cortan dimension	59x24.5x36.5cm
包装数量 Package	50个/箱(50Pcs/CTN)

### 纸箱

TISSUE BOX



D-099  
超宝擦手纸箱



D-100  
超宝卷纸箱

参数 Specification

型号 Model	D-099	D-100
产品尺寸 Product size	27.5x12x37cm	27x27x12cm
包装规格 Cortan dimension	67x58x39cm(10个装)/28x12.5x37cm(1个装)	/
包装数量 Package	10个/箱(10Pcs/CTN)	10个/箱(10Pcs/CTN)

### 圆形卷纸箱

TISSUE BOX



D-370



参数 Specification

型号 Model	D-370
产品尺寸 Product size	27.5x12x27.2cm
包装数量 Package	20个/箱(20Pcs/CTN)

### 方形擦手纸箱

TISSUE BOX



D-371



参数 Specification

型号 Model	D-371
产品尺寸 Product size	27.5x10.2x20.5cm
包装数量 Package	20个/箱(20Pcs/CTN)

### 方形擦手纸箱

TISSUE BOX



D-367

参数 Specification

型号 Model	D-367
产品尺寸 Product size	27x20x10cm
包装数量 Package	20个/箱(20Pcs/CTN)

### 圆形卷纸箱

TISSUE BOX



D-368



参数 Specification

型号 Model	D-368
产品尺寸 Product size	28x12x28cm
包装数量 Package	20个/箱(20Pcs/CTN)

### 中心抽卷纸箱

TISSUE BOX



D-369



参数 Specification

型号 Model	D-369
产品尺寸 Product size	27x20x10cm
包装数量 Package	20个/箱(20Pcs/CTN)



## 浴缸防滑垫(橡胶)

BATH ANTI-SKID MAT



D-107

## 参数 Specification

型号 Model	D-107
产品尺寸 Product size	36x57cm
包装数量 Package	30片/箱(30Pcs/CTN)
颜色 Color	金鱼纹、米白色

## 手动皂角器

HAND SOAP DISPENSER



单头



双头

## 参数 Specification

型号 Model	D-053A(单头)	D-053A(双头)
产品尺寸 Product size	8x8x18cm	15x8x18cm
包装数量 Package	50个/箱(50Pcs/CTN)	50个/箱(50Pcs/CTN)

## 手动皂角器

HAND SOAP DISPENSER



单头



双头

## 参数 Specification

型号 Model	D-053B(单头)	D-053B(双头)
产品尺寸 Product size	7x8x19cm	15x8x19cm
包装数量 Package	50个/箱(50Pcs/CTN)	50个/箱(50Pcs/CTN)

## 喷香机

PERFUME DISPENSER



D-070A



D-070B

## 参数 Specification

型号 Model	D-070A	D-070B
产品尺寸 Product size	8.5x9x24cm	12x9x20.5cm
包装数量 Package	12个/箱(12Pcs/CTN)	12个/箱(12Pcs/CTN)

# 酒店用品

## HOTEL SUPPLIES

### 座地烟灰/垃圾两用桶

#### BLOCK CIGARETTE ASH/GARBAGE DUAL PURPOSE DUSTBIN

高档场所的理想选择，超宝座底烟灰/垃圾两用桶拥有简洁的线条设计和色彩鲜明的桶身颜色，耐用性极高可置于显著区域，维护要求低

- 汽车烤漆工艺，防火钢材制造
- 所有款式的底部都是为保护地面特别设计
- 黑、青绿、灰三色可选

Ideal choice in top grade places, chaobao block type cigarette ash/garbage dual purpose dustbin is with clean lines design and bright color, this dustbin can be put in conspicuous place, require low maintenance.

- Auto baking process, made from fireproof steel
- All bases are special designed for floor protection
- black, green and turquois colors are available

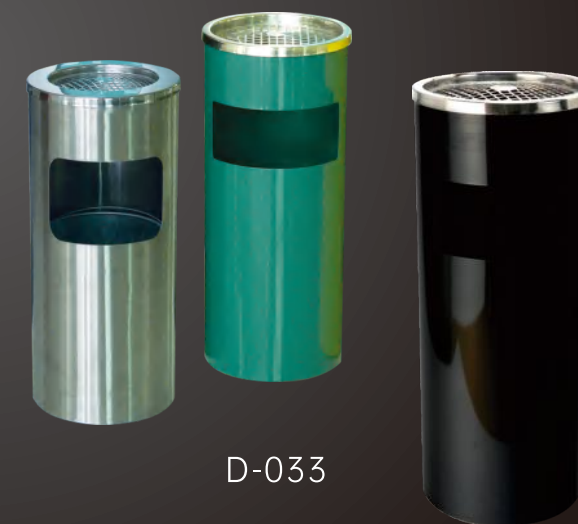

D-033



砂纹钢



D-032



#### 参数 Specification

型号 Model	D-033	D-032
产品尺寸 Product size	25x61cm	24x24x62cm
颜色 Color	● ● ●	● ● ●

### 单头伞袋机

UMBRELLA HOLDER



D-001B

参数 Specification

型号 Model	D-001B
产品尺寸 Product size	34x25x77cm
包装数量 Package	1个/箱(1Pcs/CTN)

### 双头伞袋机

UMBRELLA HOLDER



D-001A

参数 Specification

型号 Model	D-001A
产品尺寸 Product size	47x29x79cm
包装数量 Package	1个/箱(1Pcs/CTN)

### 带锁豪华型雨伞架

LUXURY UMBRELLA STAND WITH LOCK



D-005

D-004

参数 Specification

型号 Model	D-005	D-004
产品尺寸 Product size	60x30x90cm	60x45x90cm
包装规格 Cortan dimension	82x32.5x12cm	82x49x12cm
锁头 Lock head	12头	18头
包装数量 Package	1个/箱(1Pcs/CTN)	1个/箱(1Pcs/CTN)

### 带锁豪华型雨伞架

LUXURY UMBRELLA STAND WITH LOCK



D-003

D-002

参数 Specification

型号 Model	D-003	D-002
产品尺寸 Product size	110x45x90cm	110x45x90cm
包装规格 Cortan dimension	106.5x45x12cm	106.5x45x12cm
锁头 Lock head	24头	36头
包装数量 Package	1个/箱(1Pcs/CTN)	1个/箱(1Pcs/CTN)

### 带锁标准型雨伞架

STANDARD UMBRELLA STAND WITH LOCK



D-005N

D-004N

参数 Specification

型号 Model	D-005N	D-004N
产品尺寸 Product size	60x32x87cm	60x45x87cm
包装规格 Cortan dimension	82x10.5x33cm	82x10.5x50.5cm
锁头 Lock head	12头	18头
包装数量 Package	1个/箱(1Pcs/CTN)	1个/箱(1Pcs/CTN)

### 带锁标准型雨伞架

STANDARD UMBRELLA STAND WITH LOCK



D-003N

D-002N

参数 Specification

型号 Model	D-003N	D-002N
产品尺寸 Product size	108x32x87cm	108x45x87cm
包装规格 Cortan dimension	108x13x34cm	108x13x48cm
锁头 Lock head	24头	36头
包装数量 Package	1个/箱(1Pcs/CTN)	1个/箱(1Pcs/CTN)

## 自动感应擦鞋机

### SHOESHINE MACHINE

高档场所的贴心之选，超宝自动感应擦鞋机拥有智能的感应系统和强大的清洁能力，实用性极强可置于大堂、办公室等区域，维护要求低

- 红外线自动感应，无需手动操作
- 多毛刷 + 自动上油设计，硬刷除尘、软刷抛光，鞋面鞋边清洁提亮一步到位
- 低噪节能马达，运行安静且无人时自动休眠
- 金属机身搭配不锈钢踏板，简约耐用易清洁，尺寸适中不占空间
- 定期补充耗材即可，维护简单成本低

A thoughtful choice for high-end places, the Superba automatic shoe polishing machine has a smart sensing system and powerful cleaning ability, extremely practical and can be in lobbies, offices and other areas, with low maintenance requirements.

- Infrared automatic sensing, no need for manual operation
- Coarse brush automatic oiling design, hard brush for dust removal, soft brush for polishing one-step cleaning and brightening of shoe surface and edges
- Low noise energy-saving motor, runs quietly and goes into auto-sleep mode when no one is around
- Metal body with stainless steel pedal, simple, durable and easy to clean, size without taking up space
- Just regularly replenish consumables, simple maintenance and low cost



D-218



D-218

#### 参数 Specification

型号 Model	D-218	电压/电频 Voltage	220V-50Hz
产品尺寸 Product size	50x30x75cm	功率 Power	100W
包装尺寸 Packing size	53x32x79.5cm	转速 Speed	1400rpm
包装数量 Package	1个/箱(1Pcs/CTN)		

## A型豪华弹簧垫折叠加床

### A LUXURY SPRING PAD FOLDING EXTRA BED



D-008

#### 参数 Specification

型号 Model	D-008
产品尺寸 Product size	195x88x50cm
包装规格 Cortan dimension	95x56x97cm
包装数量 Package	1个/箱 (1Pcs/CTN)

## C型豪华海绵压板折叠加床

### C LUXURY SPONGE FOLDING EXTRA BED



D-010

#### 参数 Specification

型号 Model	D-010
产品尺寸 Product size	191x93x43cm
包装规格 Cortan dimension	95x31x109cm
包装数量 Package	1个/箱 (1Pcs/CTN)

**D-171H  
D-172/173  
D-174**

**芳香片**  
URINAL DEODORIZER

容量 Capacity	D-171H	200g/包
	D-172/173	60g/片
	D-174	40g/片
包装数量 Package	D-171H	5粒/包, 360粒/箱 (5pack/CTN, 360pcs/CTN)
	D-172/173	200片/箱 (200pcs/CTN)
	D-174	200片/箱 (200pcs/CTN)



**D-171H**  
香精球



**D-172/173**  
心形香精片

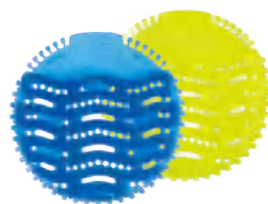

**D-174**  
EVA防溅香精片

**D-171G  
D-171J  
D-171K**

**芳香片**  
URINAL DEODORIZER

容量 Capacity	D-171G	100g/个
	D-171J	120g/个
	D-171K	100g/个
包装数量 Package	D-171G	120个/箱 (120pcs/CTN)
	D-171J	50个/箱 (50pcs/CTN)
	D-171K	50个/箱 (50pcs/CTN)

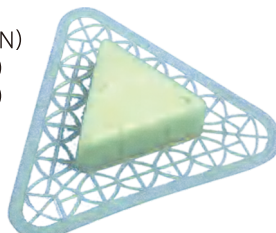

**D-171G**  
香精块



**D-171J**  
圆形香精块



**D-171K**  
三角形香精块

**D-131  
D-132**

**西班牙进口K2&K3**  
THE SPANISH IMPORTED K2K3

容量 Capacity	D-131	6KG
	D-132	7KG
包装数量 Package	D-131	3罐/箱 (3pcs/CTN)
	D-132	3罐/箱 (3pcs/CTN)



**D-131**  
西班牙进口K2



**D-132**  
西班牙进口K3

**D-116A  
CB128**

**清洁剂**  
DETERGENT

容量 Capacity	D-116A	300ML
	CB128	700ML
包装数量 Package	D-116A	15支/箱 (15pcs/CTN)
	CB128	12支/箱 (12pcs/CTN)



**D-116A**  
香口胶溶剂



**CB128**  
128万能起渍剂

**D-133C  
D-133B**

**宝而亮**  
CIF CLEANER

容量 Capacity	D-133C	500ML
	D-133B	500ML
包装数量 Package	D-133C	16支/箱 (16pcs/CTN)
	D-133B	16支/箱 (16pcs/CTN)



**D-133C**  
宝而亮



**D-133B**  
洁而亮

**D-125**

**不锈钢清洁膏**  
STAINLESS STEEL CLEANING PASTE

产品规格 Measurement	350g
包装数量 Package	48个/箱 (48pcs/CTN)



**D-125**

**D-071A** 香薰喷雾剂  
AROMATHERAPY SPRAYS

容量 Capacity 300ML  
香型 Category 沙丘/古龙/柠檬/茉莉  
Touradon/Cologne/Lemon/Jasmine  
包装数量 Package 72支/箱 (72pcs/CTN)



D-071A

**D-130** 免拆洗空调清洁宝  
AIR CONDITIONING CLEANER

容量 Capacity D-130 500ML  
包装数量 Package D-130 24支/箱 (24pcs/CTN)



D-130

**D-122A** 超亮珠  
SUPER BRIGHT BEAD

容量 Capacity 450ML  
包装数量 Package 12支/箱 (12pcs/CTN)



D-122A

**D-120** 擦铜水  
PLEDGE CLEANER

容量 Capacity D-120 400ML  
包装数量 Package D-120 12支/箱 (12pcs/CTN)



D-120

**D-122B** 洁亮珠  
PLEDGE CLEANER

容量 Capacity 350g  
包装数量 Package 12支/箱 (12pcs/CTN)



D-122B

**D-118 D-119 D-129 D-124** 去除宝  
TREASURE

产品名称 Product Name  
D-118 强力粘胶去除宝  
D-119 柏油沥青去除宝  
D-129 厨房油污泡沫清洁宝  
D-124 多功能泡沫清洁宝  
容量 Capacity  
D-118 450ML  
D-119 450ML  
D-129 500ML  
D-124 600ML  
包装数量 Package 24支/箱 (24pcs/CTN)



D-118



D-119



D-129



D-124



# 清洁剂

## CLEANING AGENT

# 七大清洁剂品牌系列

CLEANING AGENT





# 家庭装系列

## HOME SERIES



### 酒精消毒喷雾

ALCOHOL DISINFECTION SPRAY

容量 Capacity 500ML

包装数量 Package 24瓶/箱 (24pcs/CTN)

包装尺寸 Packing size 38x26x26cm



酒精消毒喷雾

### 洗手液

HAND SANITIZER

容量 Capacity 500ML

包装数量 Package 24瓶/箱 (24pcs/CTN)

包装尺寸 Packing size 52x35x16cm



洋甘菊清爽洗手液



芦荟抑菌洗手液



免洗消毒凝胶

### 清新柠檬洗洁精

FRESH LEMON DETERGENT

容量 Capacity 清新柠檬洗洁精 500ML  
清新柠檬洗洁精 1.35kg  
去油王餐具净 20kg

包装数量 Package 清新柠檬洗洁精 24瓶/箱 (24pcs/CTN)  
清新柠檬洗洁精 12瓶/箱 (12pcs/CTN)  
去油王餐具净 1瓶/箱 (1pcs/CTN)

包装尺寸 Packing size 清新柠檬洗洁精 36x24x26cm  
清新柠檬洗洁精 46x26x24.6cm  
去油王餐具净 /



清新柠檬洗洁精



清新柠檬洗洁精



去油王餐具净

强效洁厕剂

POWERFUL TOILET CLEANER

容量 Capacity 500ML  
 包装数量 Package 24瓶/箱 (24pcs/CTN)  
 包装尺寸 Packing size 33x30x24.6cm



强效洁厕剂

粉状清洁剂

POWDERED CLEANER AGENT

容量 Capacity 600g  
 包装数量 Package 30瓶/箱 (24pcs/CTN)  
 包装尺寸 Packing size 37.5x34.3x19cm



管道疏通剂

地板清洁剂

FLOOR CLEANER

容量 Capacity 500ML  
 包装数量 Package 24瓶/箱 (24pcs/CTN)  
 包装尺寸 Packing size 40.5x38x24.7cm



地板清洁剂

粉状清洁剂

POWDERED CLEANER AGENT

容量 Capacity 600g  
 包装数量 Package 30瓶/箱 (24pcs/CTN)  
 包装尺寸 Packing size 37.5x34.3x19cm



洗衣机槽清洁剂



活氧爆炸盐

衣物护理

CLOTHING CARE

容量 Capacity	深层洁净护理洗衣液	2.1kg
	衣物除菌液	1.9L
包装数量 Package	深层洁净护理洗衣液	8瓶/箱 (8pcs/CTN)
	衣物除菌液	8瓶/箱 (8pcs/CTN)
包装尺寸 Packing size	深层洁净护理洗衣液	37x35x31.6cm
	衣物除菌液	33.5x31.5x30cm



深层洁净护理洗衣液



衣物除菌液

粉状清洁剂

POWDERED CLEANER AGENT

容量 Capacity	五洁去污粉	600g
	柠檬酸除垢剂	500g
包装数量 Package	五洁去污粉	30支/箱 (30pcs/CTN)
	柠檬酸除垢剂	30支/箱 (30pcs/CTN)
包装尺寸 Packing size	五洁去污粉	37.5x34.3x19cm
	柠檬酸除垢剂	37.5x34.3x19cm



五洁去污粉



柠檬酸除垢剂

清洁剂  
DETERGENT

容量 Capacity 500ML  
 包装数量 Package 24瓶/箱 (24pcs/CTN)  
 包装尺寸 Packing size 40.5x38x24.7cm



锅底黑垢去除剂



厨房重油污净

清洁剂  
DETERGENT

容量 Capacity 500ML  
 包装数量 Package 24瓶/箱 (24pcs/CTN)  
 包装尺寸 Packing size 40.5x38x24.7cm



甲醛捕捉剂



除味芳香剂

清洁剂  
DETERGENT

容量 Capacity 500ML  
 包装数量 Package 24瓶/箱 (24pcs/CTN)  
 包装尺寸 Packing size 40.5x38x24.7cm



空气清新剂



全能清洁剂

清洁剂  
DETERGENT

容量 Capacity 500ML  
 包装数量 Package 24瓶/箱 (24pcs/CTN)  
 包装尺寸 Packing size 40.5x38x24.7cm



塑壳乳胶清洁氧爆炸剂



涂鸦除胶清洁剂

清洁剂  
DETERGENT

容量 Capacity 500ML  
 包装数量 Package 24瓶/箱 (24pcs/CTN)  
 包装尺寸 Packing size 40.5x38x24.7cm



玻璃清洁剂



卫浴清洁剂

清洁剂  
DETERGENT

容量 Capacity 500ML  
 包装数量 Package 24瓶/箱 (24pcs/CTN)  
 包装尺寸 Packing size 40.5x38x24.7cm



布艺沙发窗帘清洁剂



地毯布艺窗帘抗污剂

清洁剂  
DETERGENT

容量 Capacity 500ML  
 包装数量 Package 24瓶/箱 (24pcs/CTN)  
 包装尺寸 Packing size 40.5x38x24.7cm



桌面除菌清洁剂



静电吸尘剂

超宝乐®

# 经济商用清洁剂系列

## ECONOMIC COMMERCIAL CLEANING AGENT SERIES



### 经济商用全能清洁剂

DFF011

COMMERCIAL CLEANING MULTI-PURPOSE CLEANER

#### 产品说明 / PRODUCT DESCRIPTION

能去除普通油渍、炭渍、胶渍等,只要均匀涂抹或喷洒在物品污渍表面润湿后,擦拭清洗。无腐蚀性,安全可靠,可用于瓷砖、塑料、金属、橡胶等表面,是家庭及企事业单位普遍选用的清洁用品。

#### 主要成份 / MAIN INGREDIENTS

非离子表面活性剂、阴离子表面活性剂、助洗剂、松油,不含磷。

#### 注意事项 / CAUTIONS

避免接触眼睛,若不慎接触,立即用大量清水冲洗,切勿入口。使用时戴上保护手套。

### 经济商用静电吸尘剂

DFF020

COMMERCIAL CLEANING SELECTROSTATIC PRECIPITATOR

#### 产品说明 / PRODUCT DESCRIPTION

一种专业地面保养用品,能增强地拖吸尘去污能力吸尘后的地拖极易抖去坐土,再次使用。适合于现代高档家居地面、打蜡地面、要求高清洁度地面等的使用。能有效去除地面及蜡面的尘土,脚印,使地面洁净,恢复地板蜡面光泽。

#### 主要成份 / MAIN INGREDIENTS

异链烷烃溶剂、石油衍生物、香精,不含磷。

#### 注意事项 / CAUTIONS

避免接触眼睛,若不慎接触,立即用大量清水冲洗,切勿入口,使用时戴上保护手套,请勿用饮料瓶或饮用水瓶分装,请存放于婴幼儿接触不到的地方。



### 经济商用除油剂

DFF006

COMMERCIAL CLEANING DEGREASER

#### 产品说明 / PRODUCT DESCRIPTION

除油剂适用于多种硬表面,对动植物油污能发挥卓越去污能力。特别适用于各种烘炉、平板炉、炸炉、抽油烟槽及隔网等。能迅速渗透,藉以乳化及皂化各种焦炭、油污及食物渣滓,使吃力的清洁工作也变得轻松自在。

#### 主要成份 / MAIN INGREDIENTS

非离子活性物、阴离子活性物、软水剂、香精、不含磷。

#### 注意事项 / CAUTIONS

避免接触眼睛,若不慎接触,立即用大量清水冲洗,切勿入口。使用时戴上保护手套。请勿用饮料瓶或饮用水瓶分装,请存放于婴幼儿接触不到的地方。



## 经济商用洗手液 DFF010

COMMERCIAL CLEANING HAND SANITIZER

### 产品说明 / PRODUCT DESCRIPTION

中性清洁配方，芬芳清香。对皮肤清洁，洗手不干涩，泡沫丰富易冲洗。

### 主要成份 / MAIN INGREDIENTS

水、月桂醇聚醚硫酸酯钠、氯化钠、月桂基甜菜碱、乙二醇二硬脂酸酯、椰油酰胺DEA。

### 其他微量成分 / OTHER TRACE COMPONENTS

甘油、聚乙二醇-400、EDTA二钠、香精、丙二醇CI16035、甲基氯异噻唑啉酮、甲基异噻唑啉酮、硝酸镁、氯化镁。

### 注意事项 / CAUTIONS

避免接触双眼，请勿服用。若不慎入眼，请立即用大量清水冲洗眼部。如误饮，请立即饮用牛奶，并就医诊治。



## 经济商用沐浴露 DFF029

COMMERCIAL CLEANING SHOWER GEL

### 产品说明 / PRODUCT DESCRIPTION

本品含清洁成分，性质柔和，泡沫丰富细腻，浴后令肌肤滋润幼滑。

### 主要成份 / MAIN INGREDIENTS

水、月桂醇聚醚硫酸酯钠、椰油酰胺DEA、氯化钠、月桂酰胺丙基甜菜碱、乙二醇二硬脂酸酯、香精。

### 其他微量成分 / OTHER TRACE COMPONENTS

甘油、EDTA二钠、柠檬酸、硝酸镁、甲基氯异噻唑啉酮、氯化镁、甲基异噻唑啉酮。

### 注意事项 / CAUTIONS

避免接触双眼，请勿服用。若不慎入眼请立即用大量清水冲洗。若误饮，请立即饮用牛奶，并就医诊治。

## 经济商用洗洁精 DFF046

COMMERCIAL CLEANING DETERGENT

### 产品说明 / PRODUCT DESCRIPTION

- 温和去油污配方，洁净力强，清除餐具表面污渍油腻，轻松放心
- 含优质表面活性剂，洁净餐具，卫生安全
- 实际无毒级，安全健康:无磷配方，绿色环保
- 泡沫丰富，容易过水，无残留
- 淡雅香味，自然清新

### 主要成份 / MAIN INGREDIENTS

软化水、表面活性剂、柠檬精华。

### 注意事项 / CAUTIONS

请存放于婴幼儿接触不到的地方。如果误饮，请即喝水稀释并及时就诊。



## 经济商用洗发露 DFF028

COMMERCIAL CLEANING SHAMPOO

### 产品说明 / PRODUCT DESCRIPTION

本品采用清爽配方，有效改善发质干枯毛糙，清洁头皮上多余的油脂，真正做到清爽洁净。

### 主要成份 / MAIN INGREDIENTS

水、月桂醇聚醚硫酸酯钠、椰油酰胺DEA、氯化钠、月桂酰胺丙基甜菜碱、瓜儿胶羟丙基三甲基氯化铵、香精、氨端聚二甲基硅氧烷。

### 其他微量成分 / OTHER TRACE COMPONENTS

EDTA二钠、柠檬酸、十三烷醇聚醚-12、西曲氯铵C119140、硝酸镁、乙酸、甲基氯异噻唑啉酮、CI42090、氯化镁甲基异噻唑啉酮。

### 注意事项 / CAUTIONS

避免接触双眼，请勿服用。若不慎入眼，请立即用大量清水冲洗眼部。如误饮请立即饮用牛奶，并就医诊治。



## 经济商用不锈钢保养剂 DFF021

COMMERCIAL CLEANING STAINLESS STEEL CLEANER

### 产品说明 / PRODUCT DESCRIPTION

专用于不锈钢表面清洁保养，去污力特强，能有效去除油污、锈迹。用后在不锈钢表面形成保护膜，使金属表面保持光洁如新，防尘，防手指印残留。

### 主要成份 / MAIN INGREDIENTS

异链烷烃溶剂、石油衍生物、硅油、香精，不含磷。

### 注意事项 / CAUTIONS

避免接触眼睛，若不慎接触，立即用大量清水冲洗，切勿入口，使用时戴上保护手套。请勿用饮料瓶装，请存放于婴幼儿接触不到的地方。



## 经济商用强效洁厕剂 DFF018

COMMERCIAL CLEANING ROTENT TOILET CLEANER

### 产品说明 / PRODUCT DESCRIPTION

适用于清洁尿槽、坐厕，同时可清洗洗手盆、浴缸、瓷盆、瓷砖等表面污渍，去污力强，除臭功效显著。不会伤害质地表面，清洗后，留下清香气味。

### 主要成份 / MAIN INGREDIENTS

非离子表面活性剂、阳离子表面活性剂、复合酸、香精。

### 注意事项 / CAUTIONS

避免触及皮肤或眼睛，若不慎接触，立即用大量清水冲洗，切勿入口，使用时应戴上保护手套。

## 经济商用花露水 DFF060

COMMERCIAL CLEANING MOSQUITO REPELLENT FLORAL WATER



### 产品说明 / PRODUCT DESCRIPTION

驱蚊止痒：添加有效驱蚊剂，居家、旅行、劳务可避免蚊子叮咬。  
清爽留香：萃取多种植物精华，清新凉爽室内地面环境，帮助远离蚊虫侵扰。  
清洁速干：特别添加清洁因子，有效去除地面脏污，速干因子挥发水分，快速干爽不留水印。

### 产品用途 / MAIN INGREDIENTS

驱蚊止痒、地面清洁、擦拭家具、清新空气。

### 主要成份 / MAIN INGREDIENTS

乙醇、杀菌剂、柠檬桉油、香茅油、色素。

### 使用方法 / USAGE METHOD

- 1、将本品适量直接喷于需要驱蚊的室内空间，建议约6小时补喷一次。
- 2、可喷于衣物表面从而达到驱蚊效果也可适量喷于手部、脚部等肌肤裸露部位。
- 3、把本品喷于室内地板表面，再用湿的地拖正常拖抹，也能达到驱蚊效果。

### 注意事项 / CAUTIONS

避火使用，并于阴凉处存放，皮肤敏感者及孕妇婴儿慎用，请置于婴幼儿不能触及处，外用品切勿食用，儿童应在成人监护下使用，如不慎入眼，请立即用大量清水冲洗。

## 经济商用草酸清洗液 DFF048

COMMERCIAL CLEANING OXALIC ACID CLEANSER



### 产品说明 / PRODUCT DESCRIPTION

本品适用于清洗宾馆酒店、工厂、娱乐公共场所和家庭中的瓷砖地面和墙面的水垢锈垢，卫生间马桶便池的尿垢水垢，具有强劲优良的除垢去污功能。

### 主要成份 / MAIN INGREDIENTS

草酸，非离子表面活性剂、助洗剂。

### 使用方法 / USAGE METHOD

本品兑水1:3比例涂抹于清洗物件上，用清洁工具擦刷，最后用水冲洗即可。对所洗物表面性质不明者，应先在不见的地方进行试验。如发现脱色，即清水过净，立即停止使用。

### 注意事项 / CAUTIONS

- 1、本品不能吞食。
- 2、产品应放在小孩接触不到的地方。
- 3、本品与眼睛或皮肤接触，应立即用大量清水冲洗。如仍有不适，请立即到医院就诊。
- 4、本品应于避光、干燥、阴凉处保存。
- 5、请勿与含氯产品一同使用。如84消毒液、漂白水等，以免产生有害气体。

## 经济商用84消毒液 DFG043

COMMERCIAL CLEANING 84 DISINFECTANT SOLUTION

### 主要有效成分及其含量 / MAIN ACTIVE INGREDIENTS AND THEIR CONTENT

次氯酸钠，有效氯含量3.0%-7.0%。

### 杀灭微生物类别 / GERMICIDAL EFFICACY

可杀灭大肠杆菌、金黄色葡萄球菌、白色念珠菌。

### 使用范围 / SCOPE OF USE

适用于织物及一般物体表面消毒。

### 使用方法 / USAGE METHOD

将本品用水稀释100-300倍后，用稀释液浸泡擦拭或喷洒物体表面。

杀菌对象	稀释比例	杀菌时间	杀菌方式
非清洁类 一般物体表面杀菌	1:100	10-30分钟	擦拭、浸泡、冲洗、喷洒、以喷湿为度
织物杀菌	1:200	10-30分钟	浸泡杀菌后，用清水冲洗
清洁类 一般物体表面杀菌	1:300	10-30分钟	擦拭、浸泡、冲洗、喷洒、以喷湿为度

### 注意事项 / CAUTIONS

- 1、本品为外用消毒液，不得口服，置于儿童不易触及处稀释后使用。
- 2、使用时做好防护，如皮肤不慎触及，请立即用清水冲洗。
- 3、本品对金属有腐蚀作用，慎用。
- 4、本品对织物有漂白作用会使有色衣物变黄，不宜作为彩色衣物的消毒。丝、毛织品禁用。
- 5、本品贮存过程中析出白色或者淡黄色絮状物为表面活性剂，不影响消毒效果。
- 6、贮存在避光、密封、阴凉处。



## 经济商用漂白水 DFF045

COMMERCIAL CLEANING BLEACHING WATER

### 产品说明 / PRODUCT DESCRIPTION

本品适合用于白色及不褪色纯棉、麻质及人造纤维衣物的漂白，可漂去衣物上的果汁、咖啡、茶渍、血渍等有色污渍，亦适用于厨房瓷盆、浴缸、瓷砖、垃圾桶厕所坐厕的清洁。

### 主要成份 / MAIN INGREDIENTS

次氯酸钠、稳定剂。

### 使用方法 / USAGE METHOD

衣物洗涤

一般漂洗：将漂白水稀释，随即放入衣物开始如常洗涤。(20克漂白水混合5公斤水)

特别漂洗：将漂白水稀释，随即放入衣物浸泡5至10分钟，开始如常洗涤。(30克漂白水混合5公斤水)

硬表面清洁

厕所坐厕：将漂白水稀释，倒入坐厕内刷洗，10分钟后用清水过净。(120克漂白水混合4公斤水)

瓷盆、浴缸：将漂白水稀释，倒入浴缸内刷洗，然后用清水过净。(150克漂白水混合4公斤水)

### 注意事项 / CAUTIONS

- 1、本品不适用于丝绸、毛织品、尼龙、有色织物及皮革制品。对不明衣料，使用前请于隐蔽处测试
- 2、在通风良好状态下使用。
- 3、本品与眼睛或皮肤接触，应立即用大量清水冲洗。如仍有不适，请立即到医院就诊。
- 4、勿与酸性清洁剂(如洁厕剂等)混用。
- 5、本品应于避光、干燥、阴凉处保存。





ChaoBao®

CLEAN BRIGHT

AIR CLEAN

SUPER ACE®  
超劲霸

SUPER POWER

# 经典加仑装系列

## CLASSIC GALLON SERIES

### 特光超级蜡水(免抛蜡)

本品特光之固含量极高，可迎合多方面用途来节省地板护理之人力、物力及时间。特光快干、抗尘、抗滑，不会变黄，光度持久及耐用。适用于胶地板、云石地板、水磨石地、水晶油处理后之木地板等。

主要成份：金属交联聚合物，不含磷。

用法：将地面彻底清洁并风干后，用微纤尘推将蜡水均匀薄层涂布，待干燥后再涂第二层。建议使用温度15C以上。

容量 Capacity

3.8L

19L



DFF001

Brand 品牌 ChaoBao®



DFF001J

Brand 品牌 CLEAN BRIGHT



DFF001X

Brand 品牌 AIR CLEAN



Brand 品牌 SUPER ACE®  
超劲霸



Brand 品牌 SUPER POWER

### 免抛面蜡

本品是一种高档地板上光蜡，适合于免抛涂蜡，而且使地板易于保养。本品适用于各种材质地板，形成镜亮蜡层表面特别持久耐用，能防止地面被洗涤剂、划痕、滑擦、鞋跟摩擦等伤害。

主要成份：金属交联聚合物，不含磷。

用法：1.预备工作：除去旧蜡，清水洗净并吹至完全干燥。2.使用本品：(如有必要可以先涂1-2层底蜡)用清洁涂水器或微纤尘推均匀薄层涂布本品，涂布后干燥60分钟以上需逐层涂布，每一层均需完全干燥后才可继续涂下一层。3.日常保养每天用拖布除去表面污物。如需去除油污痕迹，可用中性全能清洁剂(绿水)稀释后拖布沾湿拖擦。对严重污垢地面可用自动刷地机配合绿水刷洗地板。所用清洁剂应不含肥皂、氨水、强碱和丁基溶剂等特质。

容量 Capacity

3.8L

19L



DFF002

Brand 品牌 ChaoBao®



DFF002J

Brand 品牌 CLEAN BRIGHT



DFF002X

Brand 品牌 AIR CLEAN



Brand 品牌 SUPER ACE®  
超劲霸



Brand 品牌 SUPER POWER

## 清洁磨光蜡

本品是一种高光亮地板磨光蜡，干固快速，抛光容易是节省时间和劳力的地板保养用品，因此特别适用于物业管理单位。本品可用于一般硬性地面上蜡和保养时作修补蜡用途。

主要成份：金属交联聚合物，不含磷。

用法：用尘拖剂处理过的拖布除尘。有油污时可用拖布沾稀释的中性全能清洁剂抹擦清洁。对污垢较多处全能清洁剂浓度可稍大些。对特别严重污垢可用机器进行擦洗、干燥。可对局部磨损蜡面补洒磨光蜡并磨光。

容量 Capacity	
	3.8L
	19L



DFF003

Brand 品牌 **ChaoBao®**



DFF003J

Brand 品牌 **CLEAN BRIGHT®**



DFF003X

Brand 品牌 **AIR CLEAN®**



Brand 品牌 **SUPER ACE® 超劲霸**



Brand 品牌 **SUPER POWER®**

## 家私蜡

本品是浓缩型家具清洁上光剂，清洁、上光、保护、一次完成。本品广泛应用于木制品、高档家具、台桌柜、塑料搪瓷、陶瓷、胶木、皮革、乙烯塑料、瓷砖、电气仪表文件柜、金属物品、音响、电视机柜、自动售货机、办公用品以及其它要求清洁光亮表面的各种物品清洁保养。

主要成份：乳化异联烷烃、二甲基硅氧烷，不含磷。

用法：在物品表面喷上少许本品，然后用干布擦亮，也可以在抹布上倒入少许本品，抹擦物品表面，再用干布擦亮。

容量 Capacity	
	3.8L
	19L



DFF005

Brand 品牌 **ChaoBao®**



DFF005J

Brand 品牌 **CLEAN BRIGHT®**



DFF005X

Brand 品牌 **AIR CLEAN®**



Brand 品牌 **SUPER ACE® 超劲霸**



Brand 品牌 **SUPER POWER®**

## 封底底蜡

本品是一种水乳型地板底层涂蜡，具有坚硬、透明、光亮的性质。它能防止水垢、油垢等渗入地板，保护地板，减少地板保养成本。适用于纸皮石、水磨石、塑胶、云石等等材质地板。

主要成份：金属交联聚合物，不含磷。

用法：1.清洁地面：扫净地面，除去粘附物，铲除旧蜡，清水洗净并干燥。2.涂底蜡：用微纤尘推均匀涂布，均匀涂上薄层底蜡，30分钟后干燥。对多孔地面可施予较厚涂层，浸渍五分钟，在干燥前将多余的蜡液擦去。为改善表现效果，可在第一层凝固后涂布第二层。3.涂布面蜡：按面蜡使用说明涂布。

容量 Capacity	
	3.8L
	19L



DFF004

Brand 品牌 **ChaoBao®**



DFF004J

Brand 品牌 **CLEAN BRIGHT®**



DFF004X

Brand 品牌 **AIR CLEAN®**



Brand 品牌 **SUPER ACE® 超劲霸**



Brand 品牌 **SUPER POWER®**

## 起蜡水

本品为强力快捷除蜡除渍剂。具有良好的渗透和溶解能力。

主要成份：非离子表面活性剂、氢氧化钠有机胺，不含磷。

用法：先用1份本品兑4份温水再用涂蜡拖布将要除蜡的地方涂抹，并使湿润状态保持约15分钟，可用擦地机进行清洗。清除残渣后，用清水过净。

注意：避免触及肌肤与眼睛，若已接触，立即用大量清水冲洗，切勿入口。使用时最好戴上保护手套。

容量 Capacity	
	3.8L
	19L



DFF013

Brand 品牌 **ChaoBao®**



DFF013J

Brand 品牌 **CLEAN BRIGHT®**



DFF013X

Brand 品牌 **AIR CLEAN®**



Brand 品牌 **SUPER ACE® 超劲霸**



Brand 品牌 **SUPER POWER®**

## 高泡地毯清洁剂

专业地毯除渍清洁剂，适用于各种长短毛地毯。高浓度配方，泡沫丰富，去渍力强。洗后令地毯光洁、柔软、蓬松、鲜艳如新。如配合多功能洗地毯机使用，效果更佳。

成分特性：非离子活性物、阴离子活性物、丙烯酸聚合物、微黄液体、熏衣草香、不含磷。

用法：用1份本品兑20份水，加入洗地毯机清水箱内即可。

注意：切勿入口，避免触及眼睛，若不慎触及，应立即用大量清水冲洗后就医，只供专业使用，用后请拧紧瓶盖。

容量 Capacity	
	3.8L
	19L



DFF007

Brand 品牌 



DFF007J

Brand 品牌 



DFF007X

Brand 品牌 



Brand 品牌 



Brand 品牌 

## 地毯起渍剂

此除渍剂功效特强，本品适合清洗毛、麻、棉、各种化纤、混纺和尼龙、地毯上的茶渍、咖啡、油渍、饮料等污渍。

成分特性：非离子活性物、氢氧化钾、溶剂、熏衣草。

用法：倒少许本品先喷洒在地毯的污渍上，再用清洗机清洗即可。

注意：切勿入口，避免触及眼睛，若不慎触及，应立即用大量清水冲洗后就医，只供专业使用，用后请拧紧瓶盖。

容量 Capacity	
	3.8L
	19L



DFF009

Brand 品牌 



DFF009J

Brand 品牌 



DFF009X

Brand 品牌 



Brand 品牌 



Brand 品牌 

## 低泡地毯清洁剂

专业地毯除渍清洁剂，适用于各种长短毛地毯。高浓度配方，泡沫特少，去渍力强。洗后令地毯光洁柔软，富有弹性、鲜艳如新。如配合蒸汽式洗地毯使用，效果更佳。

成分特性：非离子活性物、丙烯酸聚合物、微黄液体、熏衣草香、不含磷。

用法：用1份本品兑12份水，加入洗地毯机清水箱内即可。

注意：切勿入口，避免触及眼睛，若不慎触及，应立即用大量清水冲洗后就医，只供专业使用用后请拧紧瓶盖。

容量 Capacity	
	3.8L
	19L



DFF008

Brand 品牌 



DFF008J

Brand 品牌 



DFF008X

Brand 品牌 



Brand 品牌 



Brand 品牌 

## 洗手液

中性,温和,芬芳清香。本品适用于悬挂式皂液器用，含有润肤剂。

成分特性：表面活性剂、羊毛脂、甘油、白色珠光、粉色触感气息。

用法：将手弄湿，取少量洗手液轻揉双手至起泡，用1份洗手液兑2份清水，如用皂液器无需加水。对皮肤无刺激作用。

注意：切勿入口，避免触及眼睛，若不慎触及，应立即用大量清水冲洗后就医，只供专业使用，用后请拧紧瓶盖，如误饮，请立即饮用牛奶，并就医诊治。

容量 Capacity	
	3.8L
	19L



DFF010

Brand 品牌 



DFF010J

Brand 品牌 



DFF010X

Brand 品牌 



Brand 品牌 



Brand 品牌 

## 全能清洁剂(中性/碱性配方)

能去除油渍、炭渍、胶渍等，只要均匀涂抹或喷洒在物品污渍表面即可，无需用力擦。无腐蚀性，安全可靠，可用于磁砖、塑料、金属、橡胶等表面，是家庭及企事业单位普遍选用的清洁用品。

成分特性：非离子表面活性剂、阴离子表面活性剂、助洗剂、溶剂、松油醇、不含磷。

用法：一般表面清洁1份本品兑水100份，用抹布揩拭，地板清洗1份本品兑水40份，进行清洗，顽固污渍与油渍清洗1份本品兑水5份，用喷雾瓶喷洒，再用后抹布揩拭。

注意：避免接触眼睛，若不慎接触，立即用大量清水冲洗，切勿入口，使用时戴上保护手套。

容量 Capacity	
	3.8L
	19L



DFF011

Brand 品牌 



DFF011J

Brand 品牌 



DFF011X

Brand 品牌 



Brand 品牌 



Brand 品牌 

## 化泡剂

本品经由浓缩硅化物乳化而成。可减除各种水质泡，特别适用于硷化物形成的泡。有效地消除和抑制清洗或机械操作过程中产生的泡，有效地保护吸水机及地毯抽洗机。同时大大减少操作及维修的工作强度。

成分特性：乳化二甲基硅氯烷、溶剂、不含磷。

用法：启动机械前，将化泡剂直接倒进机械污水箱内即可，每10升容器建议加入25~35ML化泡剂原液。

注意：切勿入口，避免触及眼睛，若不慎触及，应立即用大量清水冲洗后就医，只供专业使用，用后请拧紧瓶盖。

容量 Capacity	
	3.8L
	19L



DFF012

Brand 品牌 



DFF012J

Brand 品牌 



DFF012X

Brand 品牌 



Brand 品牌 



Brand 品牌 

## 除油剂

除油剂适用于厨房范围，对一切油污能发挥卓越去污能力。特别适用于各种洪炉、平板炉、炸炉、抽油烟槽及隔网等。能迅速渗透，藉以乳化及皂化各种焦炭、油污及食物渣滓使吃力的清洁工作也变得轻松自在。

成分特性：非离子活性物、阴离子活性物、软水剂、丙二醇甲醚、柠檬香。

用法：普通污渍，用1份本品兑8份水，或视乎污渍程度而调节，可用作喷洗、浸洗或刷洗；重污渍，直接将除油剂喷涂表面，待5至10分钟，用刷洗或喷洗方法去掉油污。

注意：切勿入口，避免触及眼睛，若不慎触及，应立即用大量清水冲洗后就医，只供专业使用，用后请拧紧瓶盖。

容量 Capacity	
	3.8L
	19L



DFF006

Brand 品牌 



DFF006J

Brand 品牌 



DFF006X

Brand 品牌 



Brand 品牌 



Brand 品牌 

## 绿水(中性除菌清洁剂)

绿水是日常保养地板的必需品，气味清新，泡沫小，渗透力极强，能快速清除地面污渍而不损蜡面光泽，中性配方，不需过水，拖抹后蜡面在磨光处理后更加光亮，并有一定的消毒作用。

成分特性：非离子表面活性剂、阴离子表面活性剂、季铵盐、不含磷。

用法：一般表面清洁取1杯本品(约500g)兑入1桶水中(约15Kg)，拖抹蜡面地板。顽固污渍1份本品加4份清水，拖抹蜡面地板，再补蜡抛光。

注意：切勿入口，避免触及眼睛，若不慎触及，应立即用大量清水冲洗后就医，只供专业使用，用后请拧紧瓶盖。

容量 Capacity	
	3.8L
	19L



DFF014

Brand 品牌 



DFF014J

Brand 品牌 



DFF014X

Brand 品牌 



Brand 品牌 



Brand 品牌 

## 洗石水

用高浓缩配方，能快速除去马赛克等石面上的顽固污渍，锈渍，去污力特强。使用时视污渍度稀释20-50倍，请注意安全使用。

成分特性：盐酸、磷酸等复合酸、缓蚀剂、不含磷。

### 安全须知：

- 1、本品严禁吞食和接触皮肤
- 2、本品仅供专业人员稀释后使用
- 3、使用时，请戴好手套、口罩、护目眼镜



DFF015

Brand 品牌 **ChaoBao®**



DFF015J

Brand 品牌 **CLEAN BRIGHT®**



DFF015X

Brand 品牌 **AIR CLEAN®**



Brand 品牌 **SUPER ACE®**  
超劲霸



Brand 品牌 **SUPER POWER®**

## 铝品光亮剂

有效清洁及擦亮铝、铝合金、铁器等表面。消除金属表面的锈斑有特效清洗后用水过净。

成分特性：非离子表面活性剂、磷酸缓蚀剂。

注意：本产品属碱性可能刺激皮肤请带耐碱手套使用，避免触及食物和眼睛，若不慎触及，应立即用大量清水冲洗后就医使用时应保持现场空气流通使用后请拧紧瓶盖远离儿童，只供专业人使用。



DFF017

Brand 品牌 **ChaoBao®**



DFF017J

Brand 品牌 **CLEAN BRIGHT®**



DFF017X

Brand 品牌 **AIR CLEAN®**



Brand 品牌 **SUPER ACE®**  
超劲霸



Brand 品牌 **SUPER POWER®**

## 空气清新剂(柠檬/茉莉/白兰/国际香型)

本品是从鲜花，水果的植物油提取的芬芳的气味，赋予宜人芳香，清新空气，消除物件的异味和臭气，可喷向空气和物件，不宜食用。

成分特性：香精、乳化剂、玉兰香、不含磷。

用法：一般使用原液，也可用水稀释3~5倍使用。



DFF016

Brand 品牌 **ChaoBao®**



DFF016J

Brand 品牌 **CLEAN BRIGHT®**



DFF016X

Brand 品牌 **AIR CLEAN®**



Brand 品牌 **SUPER ACE®**  
超劲霸



Brand 品牌 **SUPER POWER®**

## 强效洁厕剂

本品使用于清洁尿槽、坐厕，同时可清洗洗手盆、浴缸、瓷盆、瓷砖等表面污渍，去污力强除臭功效显著，清洗后，留下清香气味。

成分特性：非离子表面活性剂、阴离子表面活性剂、磷酸复合酸、松油、不含磷。

用法：1份本品兑6份水，将其喷到清洗物表面，进行清洗，数分钟后用清水过净即可。对所洗物表面性质不明者，应先在不显见的地方进行试验，如发现脱色，即用清水过净，立即停止试用。

注意：避免接触皮肤及眼睛，若不慎接触，立即用大量清水冲洗，切勿入口。使用时戴上保护手套。



DFF018

Brand 品牌 **ChaoBao®**



DFF018J

Brand 品牌 **CLEAN BRIGHT®**



DFF018X

Brand 品牌 **AIR CLEAN®**



Brand 品牌 **SUPER ACE®**  
超劲霸



Brand 品牌 **SUPER POWER®**

## 酸性清洁剂

专业独特配方，适合于不能用碱性清洁剂进行清洁的物品，例如：铝、纸皮石、瓷、铜、不锈钢等的表面。

成分特性：非离子表面活性剂、盐酸复合物。

用法：将少量清洁剂喷到清洗物表面，用力擦拭，数分钟后用清水冲净。清洗浴盆、马赛克或水泥地面、铝钢表面等，用1份本品加6份水，进行清洗。对所洗物表面性质不明者，应先在不显见的地方进行试验，如发现脱色，即用清水过净，立即停止使用。

注意：避免接触皮肤及眼睛，若不慎接触，立即用大量清水冲洗，切勿入口。使用时戴上保护手套。



DFF019

Brand 品牌 **ChaoBao®**



DFF019J

Brand 品牌 **CLEAN BRIGHT®**



DFF019X

Brand 品牌 **AIR CLEAN®**



Brand 品牌 **SUPER ACE®**  
超劲霸



Brand 品牌 **SUPER POWER®**

## 静电吸尘剂

本品为一种专业地面保养品，能增强尘推吸尘去污能力，吸尘后的地拖极易抖去尘土适合于现代高档家居地面，打蜡地面，要求高清洁度地面等的使用。只需将本品喷于尘推底部，晾干后直接使用。用后可轻松抖去尘土。本品存放时应远离火源。

成分特性：异链烷烃溶剂、石油衍生物、透明液体、香蕉香精、不含磷。



DFF020

Brand 品牌 **ChaoBao®**



DFF020J

Brand 品牌 **CLEAN BRIGHT®**



DFF020X

Brand 品牌 **AIR CLEAN®**



Brand 品牌 **SUPER ACE®**  
超劲霸



Brand 品牌 **SUPER POWER®**

## 不锈钢保养剂

专用于不锈钢表面清洁保养，去污力特强，能有效去除油污、锈迹。用后在不锈钢表面形成保护膜，使金属表面保持光洁如新，防尘，防手指印残留。

成分特性：异链烷烃溶剂、石油衍生物、阳离子表面活性剂、香蕉香精。

用法：倒少许本品于干净抹布上，擦拭不锈钢表面。

注意：本产品为油性，切勿入口，避免触及眼睛，若不慎触及，应立即用大量清水冲洗后就医，接触皮肤后，请先用水清洗后用肥皂洗涤，只供专业使用，用后请拧紧瓶盖。

本品存放时应远离火源。



DFF021

Brand 品牌 **ChaoBao®**



DFF021J

Brand 品牌 **CLEAN BRIGHT®**



DFF021X

Brand 品牌 **AIR CLEAN®**



Brand 品牌 **SUPER ACE®**  
超劲霸



Brand 品牌 **SUPER POWER®**

## 玻璃清洁剂

适用于所有玻璃门窗、镜子及玻璃用具，使用方便，去污力强，能使玻璃表面恢复晶莹剔透，无需过水，不留痕迹。可溶解悬浮在玻璃上的各种污垢。

成分特性：非离子表面活性剂、溶剂、青苹果香精、不含磷。

用法：用1份本品兑水4份，用抹水器或擦窗器擦拭。

注意：本产品含溶剂，切勿入口，避免触及眼睛，若不慎触及，应立即用大量清水冲洗后就医，只供专业使用，用后请拧紧瓶盖。



DFF022

Brand 品牌 **ChaoBao®**



DFF022J

Brand 品牌 **CLEAN BRIGHT®**



DFF022X

Brand 品牌 **AIR CLEAN®**



Brand 品牌 **SUPER ACE®**  
超劲霸



Brand 品牌 **SUPER POWER®**

## 强力外墙清洁剂

本品对瓷砖、马赛克等硬质表面有非同一般的洗涤效果。对特脏及长时间的污垢，效果更佳。

特性：有刺鼻气味。

成分特性：非离子表面活性剂、盐酸、复合酸、缓蚀剂、不含磷。

用法：原液使用不稀释，直接喷洒在污渍处，稍等片刻，清水过清即可。

注意：本产品含酸性物可能刺激皮肤，请戴耐酸手套使用。切勿入口，避免触及眼睛，若不慎触及，应立即用大量清水冲洗后就医，远离儿童，只供专业使用，用后请拧紧瓶盖。

容量 Capacity	
	3.8L
	19L



DFF023

Brand 品牌 **ChaoBao®**



DFF023J

Brand 品牌 **CLEAN BRIGHT®**



DFF023X

Brand 品牌 **AIR CLEAN®**



Brand 品牌 **SUPER ACE®**  
超劲霸



Brand 品牌 **SUPER POWER®**

## 浴室清洁剂

本品用于清洁浴缸、洗手盆、尿槽、坐厕、瓷盆、瓷砖等污渍，去污力强洗后留下清香气味。

成分特性：非离子表面活性剂、阴离子表面活性剂、磷酸、香精。

用法：1份本品兑6份水，将其喷到清洗物表面，用力擦拭数分钟后用水冲洗。对所洗物表面性质不明者应先在不显见的地方进行试验，如发现脱色，即用清水过净，立即停止使用。

注意：避免接触皮肤及眼睛，若不慎接触，立即用大量清水冲洗，切勿入口。使用时戴上保护手套。

容量 Capacity	
	3.8L
	19L



DFF024

Brand 品牌 **ChaoBao®**



DFF024J

Brand 品牌 **CLEAN BRIGHT®**



DFF024X

Brand 品牌 **AIR CLEAN®**



Brand 品牌 **SUPER ACE®**  
超劲霸



Brand 品牌 **SUPER POWER®**

## 除胶剂

本品用于清除粘巾在地毯、衣物、沙发、鞋底等处的香口胶残渣，对地毯上小面积重油污、油漆、鞋油及各种油性斑痕的清除均有特效。

成分特性：石油衍生物、卤代烃。

用法：将除胶剂喷洒于污渍处(时间较长的胶垢需浸10分钟)。然后反复揉刷，抹去胶渣，如污垢严重，请重复使用。

注意：请勿靠近火源，远离儿童，只供专业使用，用后请拧紧瓶盖。

容量 Capacity	
	3.8L
	19L



DFF026

Brand 品牌 **ChaoBao®**



DFF026J

Brand 品牌 **CLEAN BRIGHT®**



DFF026X

Brand 品牌 **AIR CLEAN®**



Brand 品牌 **SUPER ACE®**  
超劲霸



Brand 品牌 **SUPER POWER®**

## 中性清洁剂

本品为高活性配方，用途广泛，是一种性质温和，使用十分安全的多功能清洁剂，对各种表面的污垢、油迹的去除均有效。在地板保养中，适用蜡面的日常清洁保养，特别在使用起蜡水后，用于中和和清除起蜡手的余渍。

适用范围：适合所有耐水表面保洁工作。

用法：根据污垢严重程度稀释使用，配合地拖或洗地机使用，也可以手工直接刷洗，然后用清水过干净即可。

容量 Capacity	
	3.8L
	19L



DFF027

Brand 品牌 **ChaoBao®**



DFF027J

Brand 品牌 **CLEAN BRIGHT®**



DFF027X

Brand 品牌 **AIR CLEAN®**



Brand 品牌 **SUPER ACE®**  
超劲霸



Brand 品牌 **SUPER POWER®**

## 洗发露

本品采用高效去屑清爽配方，有效调理、平衡油脂分泌，去除头皮上多余油脂，彻底清除头皮屑和抑制头皮屑产生，止头痒，真正做到清爽去屑不伤发。

注意：本品不含磷！

容量 Capacity	
	3.8L
	19L



DFF028

Brand 品牌 **ChaoBao®**



DFF028J

Brand 品牌 **CLEAN BRIGHT**



DFF028X

Brand 品牌 **AIR CLEAN**



Brand 品牌 **SUPER ACE®**  
超劲霸



Brand 品牌 **SUPER POWER**

## 沐浴露

本品含多种天然成份，性质温和，酸碱度最接近皮肤，浴后令皮肤滋润幼滑，不会干燥及痕痒。

注意：本品不含磷！

容量 Capacity	
	3.8L
	19L



DFF029

Brand 品牌 **ChaoBao®**



DFF029J

Brand 品牌 **CLEAN BRIGHT**



DFF029X

Brand 品牌 **AIR CLEAN**



Brand 品牌 **SUPER ACE®**  
超劲霸



Brand 品牌 **SUPER POWER**

## 全能油污净

本品能迅速渗透、乳化及皂化多种油污，针对厨房地面、墙面、菜板、排气扇、抽油烟机等动植物油污及部分液体机械油污有卓越的去油作用，也对防水耐碱表面的原珠笔渍等污垢有清除效果，令清洁表面恢复如新。

适用范围：厨房(餐厅)地面、工厂、机修，加工场所及地毯的除油清洁。

用法：请保持使用环境空气流通。如用于油漆表面，请用稀释溶液，如配合机械和高压清洗，可将稀释比例适当提高。

- 1、手工清洗：将本品原液或稀释液喷洒在污垢表面，稍带片刻用刷子刷洗或直接用浸有本品的软布擦拭物件表面，然后用清水过干净。(若清洗门窗或玻璃幕墙则无需过水)。
- 2、机械清洗：将本品稀释液倒进洗地机的水箱进行刷洗后，用吸水机吸去污水，或将本品直接喷洒到污垢表面，稍等几分钟然后用高压射水机清洗干净。

容量 Capacity	
	3.8L
	19L



DFF030

Brand 品牌 **ChaoBao®**



DFF030J

Brand 品牌 **CLEAN BRIGHT**



DFF030X

Brand 品牌 **AIR CLEAN**



Brand 品牌 **SUPER ACE®**  
超劲霸



Brand 品牌 **SUPER POWER**

## 二合一洗发/沐浴露

本品是一种温和的洗发沐浴露，它特殊的弱酸性配方可同时清洁肌肤滋润秀发，用后令秀发和肌肤清爽怡人。

注意：本品不含磷！

容量 Capacity	
	3.8L
	19L



DFF031

Brand 品牌 **ChaoBao®**



DFF031J

Brand 品牌 **CLEAN BRIGHT**



DFF031X

Brand 品牌 **AIR CLEAN**



Brand 品牌 **SUPER ACE®**  
超劲霸



Brand 品牌 **SUPER POWER**

## 灯饰清洁剂

本品采用浓缩型配方，添加高分子聚合物和悬浮分散剂，能有效清洗各种灯饰表面附着的浮环、油污等污染物。

**适用范围：**适用于各种材质灯饰清洁，如水晶灯饰、吸顶灯量、树脂灯人造石灯、天然石灯具等。

**用法：**视污渍轻重确定兑水比例，稀释，配合百洁布清洗，并可配合低压水枪进行金属骨架清洗。

容量 Capacity	
	3.8L
	19L



DFF032

Brand 品牌 **CharlesBarnes**



DFF032J

Brand 品牌 **CLEAN BRIGHT**



DFF032X

Brand 品牌 **AIR CLEAN**



Brand 品牌 **SUPER ACE**  
超劲霸



Brand 品牌 **SUPER POWER**

## 空调清洁剂

本品是根据尘垢和油污的生成原理，采用电化高科技成果和高效去污剂等材料配制而成，通过化学反应产生的丰富泡沫有效地将附着在空调翅片的油污由里往外彻底清除，令翅片光洁如新，同时降低翅片表面的静电，减少尘埃再次积聚并有效保证空调的散热性能。

**适用范围：**适合专业空调维修人员对空调翅片除垢除渍清洁工作。

**用法：**先将翅片用水淋湿，如尘污太厚可用热水冲洗，然后将本品喷洒在翅片上(亦可用软刷或布蘸本品涂刷在翅片上)，待反应3-7分钟，用清水冲洗干净，即可达到去尘、除油、镀膜、降静电的效果。

容量 Capacity	
	3.8L



DFF035

Brand 品牌 **CharlesBarnes**



DFF035J

Brand 品牌 **CLEAN BRIGHT**



DFF035X

Brand 品牌 **AIR CLEAN**



Brand 品牌 **SUPER ACE**  
超劲霸



Brand 品牌 **SUPER POWER**

## 布艺沙发清洁剂

本品含有浓缩型高活性表面活性剂，内含特效织物增艳剂、去污剂及污渍分散剂，快速高效清洁布艺沙发表层中的油渍、色渍等其他污渍。本品干燥快，泡沫丰富细腻，去污能力强，洗后令织物光洁鲜艳。

**适用范围：**适用于各种花色布艺沙发清洁保养。

**用法：**视污渍轻重确定兑水比例，稀释，配合沙发清洗机使用并吸干表面泡沫或配合干燥机快速干燥布质表面。

容量 Capacity	
	3.8L
	19L



DFF033

Brand 品牌 **CharlesBarnes**



DFF033J

Brand 品牌 **CLEAN BRIGHT**



DFF033X

Brand 品牌 **AIR CLEAN**



Brand 品牌 **SUPER ACE**  
超劲霸



Brand 品牌 **SUPER POWER**

## 洗洁精

**产品特点：**温和去油污配方，洁净力强，清除餐具表面污渍。含优质表面活性剂卫生安全。泡沫丰富，容易过水，无残留。淡雅香味，自然清新。

**成分特性：**软化水、表面活性剂、柠檬精华。

**用法：**加本品数滴于清水中，将餐具浸泡，再用清水冲洗干净。

**注意：**请存放于婴幼儿接触不到的地方，如果误饮，请立即喝水稀释并及时就诊。

容量 Capacity	
	3.8L
	19L



DFF047

Brand 品牌 **CharlesBarnes**



DFF047J

Brand 品牌 **CLEAN BRIGHT**



DFF047X

Brand 品牌 **AIR CLEAN**



Brand 品牌 **SUPER ACE**  
超劲霸



Brand 品牌 **SUPER POWER**

## 炉灶清洁剂

本品是一种含有碱溶剂和有机清洁的液体高效脱脂剂，专为清洁厨房及炉灶油腻和食物污渍，它的特别配方能清除普通清洁剂所不能去除的顽固、坚硬的油焦。(油漆或铝质表面禁用)特殊配方、强力化油，能迅速分解油脂食物污渍。使用方便、经济、低泡配方过水容易。

成分特性：苛性碱、两性表面活性剂、溶剂。

容量 Capacity
 3.8L
 19L



DFH004

Brand 品牌 **CharlesBarnes**



DFH004J

Brand 品牌 **CLEAN BRIGHT**



DFH004X

Brand 品牌 **AIR CLEAN**



Brand 品牌 **SUPER ACE**  
超劲霸



Brand 品牌 **SUPER POWER**

## 强力化油清洁剂

本品是一种功能众多的清洁剂，最适用于清洗地板和其它硬质表面，它能渗透污垢、污渍，且不留下任何斑痕和垢膜。含有特殊化油成份，对油垢的清除特别有效。含有金属保护剂，不会对金属产生腐蚀。

成分特性：非离子表面活性剂、碳酸钠、醇醚、EDTA。

容量 Capacity
 3.8L



DFH014

Brand 品牌 **CharlesBarnes**



DFH014J

Brand 品牌 **CLEAN BRIGHT**



DFH014X

Brand 品牌 **AIR CLEAN**



Brand 品牌 **SUPER ACE**  
超劲霸



Brand 品牌 **SUPER POWER**

## 除菌除味剂

本品为一种多用途新型季胺化合物消毒剂，它结合了季胺化合物的优点和水质调节剂、干燥剂以及除臭成份，发挥多种功效，专门用于手工操作。能安全、有效地应用于卧室、储物室、浴室、厕所、冰箱、仓库、垃圾房，能渗透到臭味源头，消除气味。是控制霉菌的最佳产品。建议配成0.5%溶液使用。

成分：季胺盐、溶剂、香精。

容量 Capacity
 3.8L
 19L



DFH011

Brand 品牌 **CharlesBarnes**



DFH011J

Brand 品牌 **CLEAN BRIGHT**



DFH011X

Brand 品牌 **AIR CLEAN**



Brand 品牌 **SUPER ACE**  
超劲霸



Brand 品牌 **SUPER POWER**

## 干泡地毯清洁剂

采用高分子聚合物的抗沉积液体配方，能将多种地毯、沙发布艺墙饰等物表面的污垢有裹着作用，而且去污力强，泡沫丰富稳定，令织物保持自然松爽，气味芳香怡人，干燥速度比一般高泡地毯水要快，提高织物使用率，如果温度低于5出现浑浊现象，不会影响使用效果。如用温水稀释使用，可提高洗涤效果。对于特殊难除污渍，应使用相应的除渍剂后再使用本品。

容量 Capacity
 3.8L
 19L



DFF046

Brand 品牌 **CharlesBarnes**



DFF046J

Brand 品牌 **CLEAN BRIGHT**



DFF046X

Brand 品牌 **AIR CLEAN**



Brand 品牌 **SUPER ACE**  
超劲霸



Brand 品牌 **SUPER POWER**

## 泡沫洗手液

本品为中性清洁配方，芬芳清香对皮肤清洁，洗手不干涩，泡沫丰富易冲洗。

成分特性：水、月桂醇聚醚硫酸酯钠、椰油酰胺 DEA、甘油。

其他微量成分：EDTA 二钠、香精、柠檬酸氨端聚二甲基硅氧烷、十三烷醇聚醚-12、丙二醇、西曲氯、乙酸、甲基氯异噻唑啉酮、甲基异噻唑啉酮、硝酸镁、氯化镁。

用法：将本品装入专用泡沫皂液器，轻压泵头泵丰富泡沫于手心，充分搓揉后，再用清水冲洗干净。

容量 Capacity	
	3.8L
	19L



DFF043 Brand 品牌 **CharlesBarnes**  
 DFF043J Brand 品牌 **CLEAN BRIGHT**  
 DFF043X Brand 品牌 **AIR CLEAN**  
 Brand 品牌 **SUPER ACE** 超劲霜  
 Brand 品牌 **SUPER POWER**

## 草酸清洗液

本品适用于清洗宾馆酒店、工厂、娱乐公共场所和家庭中的瓷砖地面和墙面，炉杯瓶中的水垢锈垢，卫生间马桶便池的尿垢水垢。具有强劲优良的除垢去污功能。

成分特性：草酸，助剂。

使用方法：兑水1:3倍涂抹于清先物件上，用清洁工只擦刷，最后用水冲洗即可。

注意事项：1.本品不能吞食；2.产品应放在小孩接触不到的地方；3.本品与眼睛或皮肤接触，应立即用大量清水冲洗如仍有不适，请立即到医院就诊；4.本品应于避光、干燥、阴凉处保存。

容量 Capacity	
	3.8L
	19L



DFF048 Brand 品牌 **CharlesBarnes**  
 DFF048J Brand 品牌 **CLEAN BRIGHT**  
 DFF048X Brand 品牌 **AIR CLEAN**  
 Brand 品牌 **SUPER ACE** 超劲霜  
 Brand 品牌 **SUPER POWER**

## 漂白水

本品适用于白色及不褪色纯棉、麻质及人造纤维衣物的漂白，可漂去衣物上的果汁咖啡、茶渍、血渍等有色污渍；亦适用于厨房瓷盆、浴缸、瓷砖、垃圾桶厕所坐厕的清洁。

使用方法：1.衣物洗涤：一般漂洗将漂白水稀释，随即放入衣物开始如常洗涤(20克漂白水混合5公斤水)。2.特别漂渍：将漂白水稀释，随即放入衣物浸泡5至10分钟，开始如常洗涤。(30克漂白水混合5公斤水)。

硬表面清洁：1.厕所坐厕：将漂白水稀释，倒入坐厕内刷洗，10分钟后用清水过净。(120克漂白水混合4公斤水)。2.瓷盆、浴缸：将漂白水稀释，倒入浴缸内刷洗，然后用清水过净。(150克漂白水混合4公斤水)。

容量 Capacity	
	3.8L
	19L



DFF045 Brand 品牌 **CharlesBarnes**  
 DFF045J Brand 品牌 **CLEAN BRIGHT**  
 DFF045X Brand 品牌 **AIR CLEAN**  
 Brand 品牌 **SUPER ACE** 超劲霜  
 Brand 品牌 **SUPER POWER**

## 花香洁厕剂

适用于清洁尿槽、坐厕，同时可清洗洗手盆浴缸、瓷盆、瓷砖等表面污渍，去污力强，除臭功效显著。不会伤害质地表面，清洗后，留下清香气味。

成份：非离子表面活性剂、阴离子表面活性剂、复合酸、香精。

使用方法：用1份本品兑6份水，将其喷到清洗物表面，进行清洗，数分钟后用清水刷洗即可对所洗物表面性质不明者，应先在不见的地方进行试验。如发现脱色，即清水过净，立即停止使用。

注意：避免触及皮肤或眼睛，若不慎接触，立即用大量清水冲洗，切勿入口，使用时应戴上保护手套。

容量 Capacity	
	3.8L
	19L



DFF054 Brand 品牌 **CharlesBarnes**  
 DFF054J Brand 品牌 **CLEAN BRIGHT**  
 DFF054X Brand 品牌 **AIR CLEAN**  
 Brand 品牌 **SUPER ACE** 超劲霜  
 Brand 品牌 **SUPER POWER**

## 地板清洁剂

能去除油渍、炭渍、胶渍等，只要均匀涂抹或喷洒在物品污渍表面即可，无需力擦。无腐蚀性能去除油渍、炭渍、胶渍等性，安全可靠，可用于瓷砖、塑料、金属、橡胶等表面，是家庭及企事业单位普遍选用的清洁用品。

**成分特性：**非离子表面活性剂、阴离子表面活性剂助洗剂、溶剂、松油，不含磷。

**用法：**一般表面清洁1份本品兑水100份，用抹布揩拭，地板清洁1份本品兑水40份，进行清洗，顽固污渍与油胶清洁1份本品兑水5份，用喷雾瓶喷洒，再用抹布拭。

**注意：**避免接触眼睛，若不慎接触，立即用大量清水冲洗，切勿入口，使用时戴上保护手套。

容量 Capacity	
	3.8L
	19L



DFF055

Brand 品牌 



DFF055J

Brand 品牌 



DFF055X

Brand 品牌 



Brand 品牌 



Brand 品牌 

## 水锈净

较强酸性的液体。本品对重水锈、铁锈的清除有特效。可以与其它各种酸性的清洁剂产品，如洁厕净、浴室清洁剂、酸性清洁剂、铝品光亮剂等同时使用。使用之前，先小面积试用除锈清洁剂，检查对被洗物表面的光泽有无影响。清洁时可使用软布或毛刷沾除锈清洁剂擦拭。

**主要成分：**非离子表面活性剂、复合酸、缓蚀剂，不含磷。

**注意事项：**本品严禁吞食和接触皮肤，使用时请戴好橡胶手套等防护用品，浓缩产品，请稀释后使用。

容量 Capacity	
	3.8L
	19L



DFH016

Brand 品牌 



DFH016J

Brand 品牌 



DFH016X

Brand 品牌 



Brand 品牌 



Brand 品牌 

## 自动洗碗机清洁剂

专门为各类型洗碗碟机而设计的强力浓缩液体清洁剂，绝对安全，不会对任何材质餐具或洗碗机造成损害，适用于任何水质地区。理想的使用浓度为0.2%-2%，温度在60°C-70°C之间，洗涤效果最为理想。

**成分特性：**碱、螯合剂、抗再沉积剂。

**使用方法：**配合分配计量器使用，常规比例0.1%—0.5%，清洗温度65°C，适用于各种材质餐具。

容量 Capacity	
	3.8L
	19L



DFH001

Brand 品牌 



DFH001J

Brand 品牌 



DFH001X

Brand 品牌 



Brand 品牌 



Brand 品牌 

## 自动洗碗碟机催干剂

专门为各类型洗碗碟机而设计的超浓缩液体快干剂，能促进器皿迅速干燥，不留斑点，绝对安全，不会对任何材质餐具或洗碗碟机造成损害。适用于不同水质地区。理想的使用浓度为0.02%-0.1%，温度在82°C-90°C之间，干透效果最为理想。

**成份：**聚醚、葡萄糖酸钠，不含磷。

**使用方法：**具体使用方法请向本公司专业人员查询。

容量 Capacity	
	3.8L
	19L



DFH002

Brand 品牌 



DFH002J

Brand 品牌 



DFH002X

Brand 品牌 



Brand 品牌 



Brand 品牌 



## DFF060 驱蚊花露水

**产品特点:** 1.驱蚊止痒: 添加驱蚊剂, 居家旅行都能防蚊叮, 效果持久。2.清爽留香: 含植物精华, 让室内地面清新舒爽, 远离蚊虫。3.清洁速干: 含清洁因子, 去污快, 速干不留水印。  
**主要成分:** 乙醇、杀菌剂、柠檬桉油、香茅油、色素  
**使用方法:** 1.将本品适量直接喷于需要驱蚊的室内空间, 建议约6小时补喷一次。2.可喷于衣物表面从而达到驱蚊效果, 也可适量喷于手部、脚部等肌肤裸露部位。3.把本品喷于室内地板表面, 再用湿的地拖正常拖抹, 也能达到驱蚊效果。  
**注意事项:** 避火使用, 并于阴凉处存放; 皮肤敏感者及孕妇婴儿慎用; 请置于婴幼儿不能触及处; 外用品切勿食用; 儿童应在成人监护下使用, 如不慎入眼, 请立即用大量清水冲洗。

容量 Capacity  
3.8L



## DFF036 免过水洗手液

**性质温和, 高效清洁杀菌, 洗后能持续抗菌, 免水洗, 随时随地都可以在无水源的场所清洁双手, 有滋润呵护手部皮肤的功效。**  
**适用范围:** 适用于医院、银行、机场、火车站、超市、宾馆、餐厅等场所。  
**用法:** 将本品滴少许于手心部位, 进行全手揉擦片刻至干即可。  
**注意:** 1.外用制剂, 不得口服, 对乙醇过敏者慎用。2.本品易燃, 须远离火源。3.请勿让儿童独自触碰; 避免接触眼睛, 若不慎入眼用清水冲洗即可。

容量 Capacity  
3.8L



## DFF037 烤炉烤箱清洁剂

**本品采用迅速去除油污的超强配方, 专为重油污而设计, 分解顽固油渍, 污垢更迅速, 更充分, 省时省力。擦洗后物体表面形成保护膜, 保持洁净, 且易于下次清洁。环保、无毒。**  
**用法:** 直接喷洒于物体表面, 用刷子或者抹布擦拭, 再过水干净即可。

容量 Capacity  
3.8L



## DFF038 多用途清洁剂

**本品为多功能中性清洁剂, 适合于清洗所有硬表面, 如炉具、墙壁、家具、陶瓷、窗户、地板等。**  
**使用方法:** 1.轻污垢表面: 家具、墙壁、窗户等用本品40ml溶于4L水中, 用喷雾器或海绵擦洗, 然后用清水冲洗。2.重污表面: 炉具、地板等用本品100ml溶于4L水中, 用喷雾器或海绵擦洗, 然后用清水冲洗。  
**注意事项:** 本品对皮肤和粘膜有损害, 清洁时请戴手套。

容量 Capacity  
3.8L



## DFF039 藻类霉菌去除剂

**本品是一种强效的藻类霉菌清除剂, 能消除室外文化广场基石、碑石、人行通道等表面, 天然沉积物藻类及窗框内外的青苔藻类等, 并具极强的除菌作用, 使用简单, 效率高。**  
**适用范围:** 各种石材、金属、塑料等材质表面除藻去霉菌。  
**用法:** 视污渍轻重确定兑水比例, 稀释, 直接喷洒于藻类表面, 湿润1-3分钟后用低压式高压水枪冲洗即可。

容量 Capacity  
3.8L



## DFF049 车道清洁剂

**本产品采用表面活性剂和特殊溶解酶科技, 能迅速渗透污渍瓦解其内部结构, 温和配方, 不刺激, 一喷一擦即可软化分解去除车道上的各种污渍。**  
**产品成分:** 表面活性剂、溶剂、助剂等。  
**适用范围:** 本品用于清理柏油沥青、油渍、顽固污渍等表面清理。

容量 Capacity  
3.8L



## DFF050 除臭剂

**产品特性:** 源自美国天然植物Nature's Mist配方, 无毒无色, 安全舒适瞬间捕捉、吸附、包裹、整合空气中各覆异味。如烟味、地毯臭味空调异味、食物异味, 呕吐异味, 鞋臭味, 卫生间下水道异味等, 同时抑制病菌滋生。  
**产品成分:** 鹿蹄草、桉树油、樟树油等数十种天然植物精华素、蒸馏水。

容量 Capacity  
3.8L



## DFF051 免洗消毒凝胶

**杀灭微生物类别:** 金黄色葡萄球菌、绿脓杆菌、大肠杆菌和白色念珠菌; 有效抑制率为99.99%\*在实验条件下。  
**主要有效成分和含量说明:** 乙醇俗称酒精[75%+5%(V/V)]。  
**用法:** 卫生手消毒, 将消毒凝胶均匀涂擦手部1-2遍, 作用2min。  
**使用范围:** 主要用于卫生手部消毒注意事项外用消毒液, 不得口服。1.置于儿童不易触及处。2.易燃, 远离火源。3.对酒精过敏者慎用避光, 置于阴凉、干燥通风处密封保存。4.不宜用于脂溶性物体。

容量 Capacity  
3.8L



## DFF052 次氯酸消毒液

**主要有效成份及其含量:** 次氯酸水, 有效氯含量180mg/L-220mg/L。  
**杀灭微生物类别:** 本品原液在实验室条件下, 作用2.5min, 对悬液中的大肠杆菌、金黄色葡萄球菌的杀灭对数值>5.00, 按照10mL/m的用量向20m试验舱内雾化200mL原液消毒作用60min, 对白色葡萄球菌的杀灭率>99.99%。  
**使用范围:** 室内空气消毒。

容量 Capacity  
3.8L



## DFF053 酒精消毒喷雾

**杀灭微生物类别:** 杀灭金黄色葡萄球菌、铜绿假单胞菌、大肠杆菌和白色念珠菌。  
**\*有效杀灭率为99.99%在实验条件作用下3min。**  
**主要有效成分和含量:** 乙醇75%+5%(V/V)。说明: 乙醇俗称酒精。  
**使用范围:** 主要用于物体表面消毒。  
**用法:** 物体表面消毒, 将消毒喷雾均匀喷雾于物体表面使其保持湿润或擦拭物体表面2遍, 作用3min。

容量 Capacity  
3.8L



## DFF056 铝塑板清洗剂

**本品由多种表面活性剂及助剂精制而成, 专用于清洗铝塑板表面的油污、灰尘氧化层等陈旧污垢。清洗效率高, 不伤底材, 快速恢复铝塑板表面原有光泽。用于铝塑板、玻璃、瓷砖等硬表面的清洗。**  
**用法:** 将本品按1:20-40稀释后, 直接洒于铝塑板污渍表面, 静置30秒后, 用抹布或刷子刷洗, 最后用清水过净即可。  
**注意事项:** 1.本品不可饮用, 请置于儿童不易触及处。2.避免接触皮肤和眼睛, 如不慎入眼, 请立即用大量清水冲洗。3.使用本品时, 请戴好橡胶手套等必要的防护措施。4.不可与其他清洁剂混用, 不明材质请先于隐蔽处小面积试用。

容量 Capacity  
3.8L



## DFF057 乳胶漆清除剂

**产品说明:** 快速渗透至乳胶漆底层, 溶解乳胶漆粘成分, 使其快速从物表剥离快捷高效。适用于栏杆、窗框、地板等处附着的乳胶漆渍。  
**用法:** 将本品直接喷洒在乳胶漆渍表面, 静置1分钟左右, 用毛巾轻轻擦除即可, 较厚污渍可重复上述操作。  
**注意事项:** 1.本品不可饮用。请置于儿童不易触及处。2.避免接触皮肤和眼睛, 如不慎入眼, 请立即用大量清水冲洗15分钟。3.作用本品时, 请好橡胶手套等必要的防护措施。4.不可与含氯消毒剂混用, 不明材质请先于隐蔽处小面积试用。

容量 Capacity  
3.8L



### DFF058 真石漆清除剂

**产品说明:** 快速渗透至真石漆底层, 溶解真石漆粘合成分, 使其快速从物表脱离, 快捷高效。适用于栏杆、窗框、地板等处附着的真石漆渍。  
**主要成份:** 去离子水、无机酸、表面活性剂、助剂。  
**用法:** 将本品直接喷洒在真石漆渍表面, 静置1分钟左右, 用毛巾轻轻擦除即可, 较厚污渍可重复上述操作。



### DFH003 运水烟罩清洁剂

本品是一种强力化油去垢剂, 含有特殊的表面复合活性剂, 适用于任何水质, 在冷热水中迅速溶解。含有金属保护剂, 不会侵蚀烟罩金属。低泡, 不会影响自动运水烟罩的正常运作。  
**用量:** 自动运水烟罩0.5%-2.0%清洗厨房设备1%-25%。  
**成分特性:** 非离子表面活性剂、溶剂、醇醚、阴离子表面活性剂。



### DFH005 除垢清洁剂

本品由多种温和酸及去垢剂掺合而成, 对含有高比率钙、铁、镁成份的积垢特别有效。中、低泡的配方, 专为自动洗碗碟机而设计, 消除发热管、抽水泵的水垢, 延长洗碗机使用时间。含有保护剂, 不损坏机内组件, 迅速使金属表面清洁光亮, 用法简便、省时、省力。  
**成分特性:** 非离子、表面活性剂、磷酸复合酸、缓蚀剂。



### DFH012 除菌消毒剂

本品用于清洁、消毒和除臭食物场所的各种污渍, 含次氯酸钠, 能强去除食物用具上的污渍的能力。清洁、消毒、漂白和除臭功能四合一。迅速溶解, 具有杀菌, 除霉功能。碱性适中、冲洗容易、低泡经济实惠。每8公升水使用100克本品可获得200ppm有效氯。  
**成分特性:** 表面活性剂、次氯酸钠、稳定剂。



### DFH017 快速浸银水

本品是用于清洁银器上的顽固食品污渍, 能快速消除氧化银锈, 适用于一切中西式镀银餐具器皿。能快速令被硫化的暗淡银器回复光泽。含有金属保护剂, 配成1:1或原液使用, 按正确的方法使用不会损坏银。  
**成分特性:** 柠檬酸、还原剂、软水剂。



### DFG009 油污乳化剂

本品适用于去除棉、化纤、混纺或其它合成织物上的重油污, 选用特殊的表面活性剂, 能强劲地分解织物上的油脂, 有很好的乳化脱脂力; 其荧光素能使织物更显光亮、鲜艳。  
**使用温度:** 适用于各种温度。  
**成分特性:** 醇醚、表面活性剂、溶剂、不含磷。



### DFG010 织物柔顺剂

本品适用于无上浆织物, 如羊毛织物、混纺质料、毛巾、浴巾等。其有效成份, 能迅速消除织物中的静电, 减少织物互相粘连, 使织物松软顺滑且具清新的香味。  
**使用温度:** 常温。  
**成分特性:** 阳离子表面活性剂、助剂、不含磷。



### DFG011 丝毛洗涤剂

本品采用特殊的柔和护理无色液体配方, 针对丝毛制品纤维幼细的特点在清洁的同时, 消除静电, 梳理纤维, 柔软蓬松, 保持织物天然光泽。  
**注意:** 不应与其它洗涤剂或洗衣粉混用。  
**使用温度:** 40°C-60°C。  
**成分特性:** 非离子表面活性剂、椰油酸烷醇酰胺、助剂、不含磷。



### DFG013 衣领净(预去斑剂)

本品主要对油污及蛋白质引起的疔垢有特效, 专用于衣物领口、袖口、袋门等局部重垢预洗, 在洗涤前用本品先刷洗污渍处, 从而提高洗涤效果和洗涤质量。  
**使用温度:** 常温。  
**主要成分:** 非离子表面活性剂, 阴离子表面活性剂, 醇醚, 卤代烃, 不含磷。



### DFG017 中性洗衣液

本品采用多种高效表面活性剂, 去污能力强, 不含漂白成分, 是环保型产品。  
**使用范围:** 适用于床单、毛巾、客衣等织物。  
**用法:** 50kg织物加300-500g洗衣液, 温度控制在60°C, 主洗10-20分钟。



### DFG027 乳化增白膏

本品有良好的去油、去污能力, 具有良好的增白功效, 洗后令织物亮丽、洁白。使用时间越长, 织物白净效果越明显。  
**适用范围:** 适用于一切织物。  
**使用方法:** 100kg机型投放200-300g。



### DFG028 三合一洗涤剂

本品是一种三合一功能的织物洗涤剂, 具有去污、去油, 增白的功能, 令织物亮丽洁白。常温洗涤效果也有显著效果, 若配合强力洗衣粉、增白洗衣粉乳化剂使用能减少用量和降低返洗率。使用时间越长, 织物白度越明显。  
**适用范围:** 床单, 毛巾上残留的黑渍、暗渍等。  
**使用方法:** 主洗时使用, 100kg织物加入本品800g, 助洗时使用, 100kg织物加入本品200-300g。





### DFG029 医用主洗液

本品针对医疗卫生特点，由多种表面活性剂、抗再沉积剂、阳离子杀菌剂等组成，使洗后医疗布巾更加亮洁，长期使用可防止织物发黄、发灰、降低织物破损。  
**适用范围：**任何水质条件下各种医疗布巾的洗涤。  
**使用方法：**每10kg干织物视污垢程度加入本品40-80ml，洗涤时间10-20分钟，洗涤温度50-80°C。

容量 Capacity	
	3.8L
	19L



### DFG030 医用乳化剂

本品由多种非离子表面活性剂，阳离子表面活性剂、溶剂等组成，高浓度配方使用本品后，动植物油、矿物油、药膏、药剂等去除更彻底，洗涤更容易。  
**适用范围：**重污医疗布巾的洗涤。  
**使用方法：**每10kg干织物视污垢程度，加入本品20-40ml，洗涤温度50-80°C洗涤时间10-20分钟，配合医用主洗液使用。

容量 Capacity	
	3.8L
	19L



### DFG031 医用助洗碱液

本品浓缩高效，针对医疗布巾污垢特点，能有效调节洗涤过程中溶液的PH值，增加去污力和洗净度。  
**适用范围：**医疗布巾重污渍物的洗涤。  
**使用方法：**每10kg干织物视污垢程度，加入本品30-60ml，配合医用主洗液，医用乳化液使用。

容量 Capacity	
	3.8L
	19L



### DFG032 医用氯漂剂

本品为含氯漂渍液，性能稳定，含氯量高，广谱消毒杀菌，对细菌繁殖体、细菌芽孢、甲、乙型肝炎、病毒等均有高效快速杀灭作用。  
**适用范围：**适用于白色医疗布巾的洗涤消毒。  
**使用方法：**视布巾所在环境，每10kg干织物加入本品80-100ml，要求中低温洗涤5-10分，50°C加入，然后升温75-80°C，洗涤10-15分钟。

容量 Capacity	
	3.8L
	19L



### DFG033 去血清洗剂

本品针对医疗手术室污渍特点，由多种表面活性剂、复合酶制剂、抗再沉积剂等精制而成，浓缩高效。  
**适用范围：**手术服类血渍、药渍、人体分泌物等污渍的洗涤去除，洗后衣物干净亮丽。  
**使用方法：**每10kg手术室类织物加入本品60-80ml，洗涤温度30-50°C，洗涤时间15-20分钟。

容量 Capacity	
	3.8L
	19L



### DFG034 抗菌柔顺液

本品针对医疗布巾环境特点，由多种阳离子表面活性剂，双胍类抗菌剂等精制而成，浓缩高效，具有抗静电、柔软、抗菌等功效。  
**适用范围：**医疗布巾的柔软抗菌。  
**使用方法：**每10kg干织物加入本品40-60ml，洗涤最后工序，中水位单独加入，温度30-40°C洗涤时间3-5分钟，后高脱。

容量 Capacity	
	3.8L
	19L



### DFG039 洗衣液

添加新一代非离子活性剂，中性配方，不伤手，不伤衣物纤维，低泡技术，易过水，无残留。洗涤过程有效蓬松纤维，令衣物柔软，长效芳香因子，留香特别持久。  
**适用范围：**适合于棉、麻、毛(羊绒、羽绒等)、合成纤维、混纺、雪纺、针织衫、羽绒衫、内衣、婴儿衣物的洗涤。

容量 Capacity	
	3.8L
	19L



### DFG043 84消毒液

1、本品为外用消毒液，不得口服，置于儿童不易触及处，稀释后使用。2、使用时做好防护，如皮肤不慎触及，请立即用清水冲洗。3、本品对金属有腐蚀作用慎用。4、本品对织物有腐蚀、漂白作用，会使有色衣物变黄，不宜作为有色衣物的消毒，丝、毛织品禁用。5、本品贮存过程中析出白色或者淡黄色絮状物为表面活性剂，不影响消毒效果。6、贮存在避光、密封、阴凉处。  
**用法：**将本品用水稀释 100-300倍后，用稀释液浸泡擦拭或喷洒物体表面。

容量 Capacity	
	3.8L
	19L



### DFH009 浸渍粉

本品为密胺专用清洁粉，可专门用于清除塑料、瓷碗碟及金属餐具表面上的污渍，只一次浸泡即可消除，它对碗碟无损害，含有特殊的湿润剂，能去除咖啡、茶、水果物资。实用氧化漂白剂，能安全用于塑料餐具。理想使用条件，每公升水加入6-12克本品，在60°C-70°C中效果最理想。  
**成分特性：**表面活性剂、过碳酸钠、粉剂。

容量 Capacity	
	20kg
	20kg



### DFF044 碗碟浸泡粉

本品去污能力强，能有效去除咖啡渍、茶渍。温度越高去污速度越快，持续作用时间长且用量少，无污染，安全，卫生。  
**适用范围：**适用于一切餐具。  
**用法：**按1:500的比例稀释，将餐具浸泡在每公升热水里(60-70°C)，一次浸泡即可。

容量 Capacity	
	10kg
	20kg
	25kg
	19kg



### DFH043 超浓缩餐具洗洁粉

本品是液体洗洁精的升级换代产品，采用新型进口高效洗洁因子原料，高含量、无磷、环保活性剂、助剂等制成，它改变了传统洗涤剂均为液态、用量大、成本高、易变质返稀、浑浊等特性。  
**适用范围：**适合酒楼餐馆厨房重地餐具清洗、地面清洁。  
**使用方法：**1、取适量粉直接投入水中搅拌溶化后，用泡沫海绵擦洗使用；2、取粉投入水桶中搅拌溶化成液体后，用勺舀入水池中使用；3、将粉撒放油污处，用抹布或金属丝沾水擦洗。  
**注意事项：**本品对皮肤和粘膜有损害，清洁时请戴手套。

容量 Capacity	
	20kg
	20kg



### DFF059 密胺专用清洗剂

**适用范围：**密胺仿瓷餐具、不锈钢、陶瓷、塑料餐具的去污、除渍及翻新。  
**主要成分：**过氧碳酸钠。  
**清洗液的调配：**本品与水的比例为1-20:100；水温50-80°C(清洗液配比浓度依据污渍的轻重计算)。  
**清洗方法：**一般污渍清洗，将餐具浸泡在调配好的清洗液里(浓度1%，温度50-80°C)浸泡 30-60分钟，取出餐具擦拭，然后用清水冲洗两遍即可使用。

容量 Capacity	
	20kg
	20kg



### DFF041 多功能洗洁粉

本品是一种超强去油污产品，由多种表面活性剂和溶剂配制而成，内含护肤剂、天然杀菌剂。  
**适用范围：**适用于人手、衣物、清洗地板、家具、玻璃、油烟机、厨具等，也适用于汽车维修、机械厂、模具厂、印刷厂、电动车维修等重油污行业，还适用于清洁各种不干胶、透明胶、口香糖残留物及多种其它污渍。

容量 Capacity	
	20kg
	20kg



### DFH010 通渠粉

本品是一种强碱性通渠剂，适用于疏通渠道及防备渠道被食品残渣阻塞超浓缩，快速化学反应，易溶、冲洗迅速彻底，不能用于金属铝、铜的清洗。  
**成分特性：**阴离子表面活性剂、苛性碱、硫酸钠。

容量 Capacity	
	10kg
	20kg
	25kg
	19kg



### DFH006 粉状炉灶清洁剂

本品是一种含碱性成份的特强去油污清洁剂，清除油污及焦化油垢特别有效。特有化油成份，能迅速消除火炉、烤炉、排气罩等物件的燃烧余积物，炭化油脂。低泡配方，过水容易，并能完全溶解于硬水或软水中。  
**成分特性：**表面活性剂、硅酸钠、碳酸钠、软水剂、苛性碱。

容量 Capacity	
	20kg
	20kg



### DFF040 泳池消毒片

本品具有高效消毒灭藻和黏泥剥离能力，能有效杀灭大肠杆菌，金黄色葡萄球菌等多种有害病菌，用量少，效率高。  
**适用范围：**游泳池、储水池等公共水池消毒灭藻。  
**使用方法：**每立方米水投放2克，游泳馆建议在闭馆后投放使用。

容量 Capacity	
	20kg
	20kg



### DFH008 浸银粉

本品用于清洁银器及不锈钢餐具上的顽固食品污渍，是清洁及保护合二为一的有效产品。本品溶液与铝薄片能产生电解作用，配成3%溶液，消除银质餐具表面的硫化物或氧化物，令银餐具回复其金属光泽，也可防止不锈钢表面斑点腐蚀。  
**成分特性：**表面活性剂、还原剂、软水剂。

容量 Capacity	
	20kg
	20kg



### DFF042 地毯抽洗粉

本品采用高浓缩、低泡粉体配方，去污力强，能深入纤维清楚污垢，去除地毯表面油性干性污垢，使地毯恢复自然松爽、清新爽洁。如用温水稀释使用和配合蒸汽地毯机，可提高洗涤效果。对于特殊难除污渍，应使用相应的除渍剂后再用本品。  
**适用范围：**适合酒楼、餐厅、客房、接待厅及其它公共场所多种地毯除油去污的作用。  
**用法：**根据污垢严重程度用热水稀释，将稀释液倒进地毯清洗机内进行刷洗，并尽快用吸水机将污水吸除，同时在吸水机的污水箱加入消泡剂以保护吸水电机。洗涤最后工序，中水位单独加入，温度30-40℃洗涤时间3-5分钟，后高脱。

容量 Capacity	
	20kg
	20kg



### DFC001 全能增白洗衣粉

产品介绍：本品含多种高效表面活性剂、水处理剂、增白剂和抗再沉积剂。在任何水质中均可发挥优良去污功能。  
**适用范围：**适用于台布、餐巾、制服等棉织品和合成纤维织物。  
**用法：**100kg织物加300-500g洗衣粉，温度控制在60-75℃，主洗10-20分钟。

容量 Capacity	
	20kg
	20kg
	10kg
	20kg
	25kg



### DFG001 强力高漂洗衣粉

本品为白色粉末状，由优良生物降解表面活性剂和强力去污剂组成。能很好地去除严重的污垢，对棉、麻织物的动、植物油污垢有显著的洁净功效，且省时省力。  
**成分特性：**表面活性剂、水处理剂、苛性碱。

容量 Capacity	
	20kg
	20kg
	10kg
	20kg
	25kg



### DFG002 增白彩漂洗衣粉

本品为白色粉末状，由高活性物组成。能迅速渗透到织物内层，不但去污能力强。且性质安全温和，不伤织物，再配以特殊的荧光增白剂，更能保持织物的鲜艳光亮。适用于白色及彩色的棉、聚酯、混纺或其它合成织物的漂白去除顽固色渍。  
**使用温度：**70℃-80℃。  
**成分特性：**表面活性剂、增白剂、过碳酸钠。

容量 Capacity	
	20kg
	20kg
	10kg
	20kg
	25kg



### DFG003 低温酵素洗衣粉

本品是白色粉末状，由生物活性酶为基料配制的洗衣粉。专门适应不能使用高温的织物。其独特的生物活性酶，能迅速分解织物上的汗迹、血迹、油脂及蛋白质等污垢。清洁效果显著，且不伤织物。  
**使用温度：**常温-60℃。  
**成分特性：**表面活性剂、硅酸钠、酵素。

容量 Capacity	
	20kg
	20kg
	10kg
	20kg
	25kg



### DFC001/DFG016 强力洗衣粉/强力洗衣粉(特等)

本品含多种高效表面活性剂、水处理剂、增白剂和抗再沉积剂。在任何水质中均可发挥优良去污功能。  
**适用范围：**适用于台布、餐巾、制服等棉织品和合成纤维织物。  
**使用方法：**100kg织物加300-500g洗衣粉，温度控制在60-75℃，主洗10-20分钟。

容量 Capacity	
	20kg
	20kg
	10kg
	20kg
	25kg



### DFG004 氯漂粉

本品是白色粉末状，由高效的有机氯组成的漂白剂。其分解出的活性氯能迅速漂白去污，且不伤织物。  
**使用温度：**65℃-85℃。  
**成分特性：**二氯异氰尿酸钠、硫酸钠、粉剂。

容量 Capacity	
	20kg
	20kg
	10kg
	20kg
	25kg



### DFG005 彩漂粉

本品是高效活性氧组成的漂白剂，漂白效率高，并具去污能力，不伤织物。  
使用温度：70°C-90°C。  
成分特性：过碳酸钠、硫酸钠、粉剂。

容量 Capacity	
20kg	10kg
20kg	20kg
	25kg



### DFG006 浆粉

本品为白色粉末状，由特殊配方制成的生化浆粉，具有良好的上浆效能。令织物挺拔平滑，防止织物起毛，并有一定的增白效果。  
使用温度：45°C-50°C。

容量 Capacity	
20kg	10kg
20kg	20kg
	25kg



### DFG007 除锈酸

本品主要针对水质中的铁，钙离子在织物上生成的锈斑，其独特的除锈配方，能迅速高效地螯合铁、镁、钙离子，适用于棉、麻、化纤，混纺或其它合成织物。  
使用温度：常温。

容量 Capacity	
20kg	10kg
20kg	20kg
	25kg



### DFG008 荧光中和酸

本品为浅黄色粉末，是一种独特荧光效能的酸性物质，能中和织物中残留的碱性，螯合水中的铁、钙；其荧光组份，能增加织物亮度，使织物更显光亮鲜艳，且不伤织物，并具消毒杀菌之功效。  
使用温度：常温。  
成分特性：氟硅酸钠、助剂、粉剂。

容量 Capacity	
20kg	10kg
20kg	20kg
	25kg



### DFG012 软水剂

本品是主要针对高硬水质地区洗衣用的助剂，此助剂能有效地络合水中的钙、镁离子，迅速将硬水软化，从而提高洗衣功效，且可防止因硬水矿物质沉积而造成的黄色色斑，本品应在机洗前加入。  
使用温度：适合任何温度。  
成分特性：NTA、EDTA、粉剂、白色。

容量 Capacity	
20kg	10kg
20kg	20kg
	25kg



### DFG018 特效皂粉

皂基重垢添加剂，内含织物增强剂、增白剂及去污活性成分，本品配合洗衣粉、乳化剂同时洗涤能达到更好的效果。  
适用范围：适用于一切织物。  
用法：50°C以上使用洗涤15分钟。每100公斤布草用400-1600克。

容量 Capacity	
20kg	10kg
20kg	20kg
	25kg



### DFG019 强力乳化剂

本品由多种优质表面活性剂复配而成。具有强力的除油去渍能力，能帮助织物恢复弹性，并能达到增白增艳的功效。产品可以配合强力粉及通用粉同时使用。  
适用范围：适用于一切织物。  
用法：100kg织物加200-400g乳化剂可与洗衣粉同时加入。

容量 Capacity
19L



### DFG021 干洗视油

本品为专门用于干洗机内添加的洗涤剂，具有良好的乳化去污能力，有效去除水溶性污垢，防止污垢再沉积，抗静电。  
适用范围：适用于台布、餐巾、制服等棉织品和合成纤维织物。  
用法：1kg干洗溶剂加3-5g干洗助剂。

容量 Capacity
19L



### DFG022 助洗剂1#

本品含高效有机氯漂白剂，可杀灭衣物上的有害细菌，强力去除顽固污渍及色斑。  
适用范围：适用于白色全棉和混纺，化纤织物。彩色织物尽量避免使用测试不褪色后可以考虑。  
用法：100kg织物加500-1000g氯漂剂，温度控制在60-75°C，主洗10-20分钟。

容量 Capacity
19L



### DFG023 助洗剂2#

去除彩色织物上的各类顽固污渍，茶渍、血渍、酱渍等如汗渍、果渍、令织物亮丽如新。去除常见细菌，避免交叉感染。令彩衣更艳，白衣更白，有效改善衣物变黄，变旧的现象。  
适用范围：适合于彩色织物。  
用法：100kg织物加300-500g洗衣液，温度控制在60-70°C，主洗10-20分钟。

容量 Capacity
19L



### DFG024 助洗剂3#

本品由多种优质表面活性剂复配而成。具有强力的除油去渍能力，能帮助织物恢复弹性，并能达到增白增艳的功效。产品可以配合强力粉及通用粉同时使用。  
适用范围：适用于一切织物。  
用法：100kg织物加200-400g乳化剂，可与洗衣粉同时加入。

容量 Capacity
19L



### DFG025 宾馆布草低温洗涤剂1#

本品由多种优质表面活性剂复配而成，适合常温洗涤，具有强力的除油去渍能力，能帮助织物恢复弹性，并能达到增白增艳的功效。  
适用范围：本品配合宾馆布草低温洗涤剂2#同时使用。  
用法：100kg织物加300-400g宾馆布草洗涤剂1#。

容量 Capacity
19L



### DFG026 宾馆布草低温洗涤剂2#

本品由各种优质表面活性剂复配而成，适合常温洗涤具有强力的除油去渍能力，能帮助织物恢复弹性，并能达到增白增艳的功效。  
 适用范围：本品配合宾馆布草洗涤剂1#同时使用。  
 用法：100kg织物加300-400g宾馆布草洗涤剂2#。



### DFG035 医用彩漂粉

本品是一种专用漂白剂，温和、实用、安全、可靠，具有增白增艳的功效。在中高温条件下进行漂白的同时具有强力的杀菌功能，无需另外使用杀菌剂。  
 用法：50kg织物加200-250g彩漂粉，温度控制在60-75℃，主洗10-20分钟。可与洗衣粉同时加入。  
 注意事项：阴凉干燥处存放。



### DFG036 医用中和粉

本品主要用于中和残留在洗涤后织物上的碱，是增白除锈处理同步进行时的专用中和粉剂。使用时可免或少用除氨脱灰粉，在中和的同时能除去织物上的残留氯，防止织物泛黄及破损，能节省洗涤工序，方便实用，且能达到良好的增白增艳的效果。  
 用法：50kg织物加50-80g中和粉，洗涤温度40℃，洗涤时间3-5分钟。  
 注意事项：阴凉干燥处存放。



### DFG037 医用强力洗衣粉

本品是一种强去污力的重垢型洗涤剂，可有效清除动植物油脂及矿物油等各种污渍。本品含高效增白增艳剂，洗涤后可使织物更白、更艳。  
 用法：50kg织物加300-500g洗衣粉，温度控制在60-75℃，主洗10-20分钟。  
 注意事项：阴凉干燥处存放。



### DFG038 医用氯漂粉

本品是一种安全强力漂白剂，适用于各种硬度的水质。增白效果极佳，在漂白的同时具有强力的杀菌功能，无需另外使用杀菌剂。  
 用法：50kg织物加200-250g氯漂粉，温度控制在60-75℃，主洗10-20分钟，可与洗衣粉同时加入。  
 注意事项：阴凉干燥处存放。



## 客衣类洗涤程序

装载量约50公斤

序号	工序	洗涤条件			加入洗涤剂			检测及结果
		水位	温度℃	时间	名称	用量/克	加入方法	
1	主洗	低	50-55	15分钟	增白彩漂洗衣粉	400	湿水后皂杯处加入	主洗pH=8.8-9.8
					油污乳化剂	100	湿水后皂杯处加入	
					彩漂粉	250	彩漂粉	
2	排水			1分钟				
3	第一遍过水	高		2分钟				
4	中脱排水			2分钟				
5	第二遍过水	高		2分钟				
6	排水			1分钟				
7	第三遍过水	高		2分钟				
8	排水			2分钟				
9	中和/整理	低	35-40	4分钟	荧光中和酸	100	有水后加入，补够水位后进入高脱	pH=5.8-7.0
					织物柔顺剂	300		
10	高脱排水			4分钟		到达转速后倒计时		

## 毛巾类洗涤程序

装载量约50公斤

序号	工序	洗涤条件			加入洗涤剂			检测及结果
		水位	温度℃	时间	名称	用量/克	加入方法	
1	预洗	中		2分钟				
2	排水			30秒				
3	主洗	低	75-80	20分钟	增白彩漂洗衣粉	450	湿水后皂杯处加入	主洗pH=9.8-10.8
					软水剂	150	湿水后皂杯处加入	
					油污乳化剂	150	湿水后皂杯处加入	
					彩漂粉	450	主洗8分钟后加入	
4	排水			1分钟				
5	第一遍过水	高		2分钟				
6	中脱排水			2分钟				
7	第二遍过水	高		2分钟				
8	排水			1分钟				
9	第三遍过水	高		2分钟				
10	排水			1分钟				
11	中和/整理	中	35-40	4分钟	荧光中和酸	120	有水后加入	pH=6.0-7.0
					织物柔顺剂	500		
12	高脱排水			6分钟		到达转速后倒计时		

备注：1.使用量杯或称取标准数量，此表格用量为参考数据，视具体污垢轻重可适量增减；2.毛巾中每月可用漂粉洗3天，加强消毒和去渍；3.主洗控制低水位，预估蒸汽带入的含水量。

## 床单被套类洗涤程序

装载量约50公斤

序号	工序	洗涤条件			加入洗涤剂			检测及结果
		水位	温度℃	时间	名称	用量/克	加入方法	
1	预洗	中		2分钟				
2	排水			30秒				
3	主洗	低	65-75	20分钟	增白彩漂洗衣粉	450	湿水后皂杯处加入	主洗pH=9.8-10.8
					油污乳化剂	100	湿水后皂杯处加入	
					彩漂粉	400	主洗8分钟后加入	
4	排水			1分钟				
5	第一遍过水	高		2分钟				
6	中脱排水			2分钟				
7	第二遍过水	高		2分钟				
8	排水			1分钟				
9	第三遍过水	高		2分钟				
10	排水			1分钟				
11	中和/整理	低	35-40	4分钟	荧光中和酸	100	有水后加入, 补够水位后进入高脱	pH=5.8-7.0
					织物柔顺剂	200		
12	高脱排水			5分钟			到达转速后倒计时	

## 台布厨衣类洗涤程序

装载量约50公斤

序号	工序	洗涤条件			加入洗涤剂			检测及结果
		水位	温度℃	时间	名称	用量/克	加入方法	
1	预洗	中		3分钟				
2	排水			30秒				
3	主洗	低	75-80	20分钟	增白彩漂洗衣粉	500	湿水后皂杯处加入	主洗pH=10.0-11.0
					软水剂	150	湿水后皂杯处加入	
					油污乳化剂	250	湿水后皂杯处加入	
					彩漂粉	500	主洗8分钟后加入	
4	排水			1分钟				
5	第一遍过水	高		2分钟				
6	中脱排水			2分钟				
7	第二遍过水	高		2分钟				
8	排水			1分钟				
9	第三遍过水	高		2分钟				
10	排水			1分钟				
11	中和/整理	低	50	4分钟	荧光中和酸	100	有水后加入, 补够水位后进入高脱	pH=5.8-7.0
					浆粉	400		
12	高脱排水			5分钟			到达转速后倒计时	

备注: 1.使用量杯或称取标准数量, 此表格用量为参考数据, 视具体污垢轻重可适量增减用量; 2.不褪色布草可偶尔使用氯漂粉加强清洗和消毒; 3.主洗控制低水位, 预估蒸汽带入的含水量。

### 温馨提示:

印刷或拍摄过程中可能使目录内的产品与实物颜色有轻微区别, 最终颜色以实物为准! 超宝公司不断对产品进行创新改良, 如规格及参数有所变动, 最终将以实际产品参数为准! 获取最新的产品目录资料请致电超宝集团销售部, 或访问<http://www.china-chaobao.com>

### Tips:

There may be slight difference in color between the products in the catalog and the actual product due to printing or shooting process, the final color should be based on actual product! Chaobao company is constantly innovating and improving products, if there is any change in specifications and parameters, the final product parameters will prevail! For the latest product, please call the sales department of Chaobao Group or visit <http://www.china-chaobao.com>